

**YPA-2100**  
**DIGITAL**  
**REFRACTOR**  
**User Manual**



Version: 1.3

Revision Date: 2023.12

Product Name:	DIGITAL REFRACTOR
Nome do produto:	DIGITAL REFRACTOR
Nombre del producto:	REFRACTOR DIGITAL
Ürün Adı:	DİJİTAL REFRAKTÖR
Nome prodotto:	DIGITALE RIFRATTORE
Produktname:	Digitale REFRAKTOR
Nom du produit:	NUMÉRIQUE RÉFRACTEUR
Име на продукта:	ДИГИТАЛЕН РЕФРАКТОР
Produkto pavadinimas:	Skaitmeninis foropteris
Nazwa produktu:	CYFROWY REFRAKTOR
N ázev produktu:	DIGITÁLN ÍREFRAKTOR
Toote nimi:	DIGITAALNE MÕJUR
Produkta nosaukums:	DIGITĀLS REFRAKTORS
Όνομα προϊόντος:	ΨΗΦΙΑΚΟ ΔΙΑΘΛΑΣΤΙΚΟΣ ΦΑΚΟΣ
Numele produsului:	refractorului nostru digital
Productnaam:	digitale refractor

User Manual Download link:	<a href="http://www.yeasn.com/en/">www.yeasn.com/en/</a>
Link para download do manual do usu ário:	<a href="http://www.yeasn.com/en/">www.yeasn.com/en/</a>
Manual de usuario Enlace de descarga:	<a href="http://www.yeasn.com/en/">www.yeasn.com/en/</a>
Kullanım Kılavuzu İndirme linki:	<a href="http://www.yeasn.com/en/">www.yeasn.com/en/</a>
Manuale d'uso Link per il download:	<a href="http://www.yeasn.com/en/">www.yeasn.com/en/</a>
Link zum Herunterladen des Benutzerhandbuchs:	<a href="http://www.yeasn.com/en/">www.yeasn.com/en/</a>
Lien de t éléchargement du manuel d'utilisation:	<a href="http://www.yeasn.com/en/">www.yeasn.com/en/</a>
Линк за изтегляне на ръководството за потребителя:	<a href="http://www.yeasn.com/en/">www.yeasn.com/en/</a>
Naudotojo vadovo atsisiuntimo nuoroda:	<a href="http://www.yeasn.com/en/">www.yeasn.com/en/</a>
Link do pobrania instrukcji obsługi:	<a href="http://www.yeasn.com/en/">www.yeasn.com/en/</a>
Užívateľská príručka Odkaz ke stažení:	<a href="http://www.yeasn.com/en/">www.yeasn.com/en/</a>
Kasutusjuhendi allalaadimise link:	<a href="http://www.yeasn.com/en/">www.yeasn.com/en/</a>
Lietotāja rokasgrāmatas lejupielādes saite:	<a href="http://www.yeasn.com/en/">www.yeasn.com/en/</a>
Εγχειρίδιο χρήστη Σύνδεσμος λήψης:	<a href="http://www.yeasn.com/en/">www.yeasn.com/en/</a>
Link de descărcare manual de utilizare:	<a href="http://www.yeasn.com/en/">www.yeasn.com/en/</a>
Gebbruikershandleiding Downloadlink:	<a href="http://www.yeasn.com/en/">www.yeasn.com/en/</a>

## Preface

Thank you for purchasing and using our digital refractor.



Please read this User Manual carefully before using this device. We sincerely hope that this User Manual will provide you with sufficient information to use the device.

Our pursuit is to provide people with high-quality, complete-function and more personalized devices. Information in promotional materials and packing boxes is subject to changes due to performance improvement without additional notice. Chongqing Yeasn Science - Technology Co., Ltd. reserves the rights to update the devices and materials.

If you have any questions during using, please contact at our service hotline: (86-023) 62797666, we will be very happy to help you.

Your satisfaction, our impetus!

### **Information of manufacturer**

Name: CHONGQING YEASN SCIENCE - TECHNOLOGY CO., LTD.

Address: 5 DANLONG ROAD, NANAN DISTRICT, CHONGQING, CHINA

Tel: 86-23 62797666

# Content

1. Specifications .....	1
1.1 Uses .....	1
1.2 Measurement range .....	1
1.3 Host.....	1
1.4 Power parameters .....	2
1.5 Weight and Size.....	2
1.6 Principle.....	3
1.7 Name plate and indications .....	3
2. Safety Precautions .....	5
3. Main Structure .....	9
3.1 Host.....	9
3.2 Printing base .....	11
4. Installation Method.....	13
4.1 Part List .....	13
4.2 Installation Instructions .....	13
5. Preventive inspection.....	18
5.1 Device startup.....	18
5.2 Inspection .....	18
5.3 Inspection cycle: before use every day.....	18
6. Directions for Use.....	18
6.1 Device Startup and Shutdown .....	18
6.2 Operation Interface .....	19
6.3 Preparations before Use.....	33
6.4 Standard Optometry Procedure .....	34
6.5 Binocular Functional Testing Method.....	46
6.6 Customer Self-compiled program .....	61
6.7 Communication .....	62
6.8 Pre-set ADD .....	64
7. Troubleshooting.....	64
8. Cleaning and Protection .....	64
8.1 Clean the forehead baseplate .....	64
8.2 Clean the nose baseplate.....	65
8.3 Clean the testing window .....	65

8.4 Clean external parts .....	65
9. Maintenance and Care .....	66
10. Environmental Conditions and Service Life .....	67
11. Environmental Protection .....	68
12. Manufacturer's Responsibility .....	68
13. Electrical Schematic Diagram .....	69
14. Electromagnetic Compatibility.....	69

# 1. Specifications

## 1.1 Uses

For checking the refractive state of human eye.

Contraindications: none.

Target groups of patients: adults, children.

Intended users: optometrists in hospital ophthalmology and optical shops.

Specific qualifications of device users and/or other persons: have a qualification certificate for optometry and glasses.

## 1.2 Measurement range

The measuring range conforms to the requirements in Table 1.

Table 1 Digital refractor measurement range

Item	Measuring range
Spherical power	-29.00D ~ +26.75D, Step size: 0.12D, 0.25D, 0.5D, 1D, 2D, 3D
Cylindrical power	-8.75D ~ +8.75D, Step size: 0.25D, 0.5D, 1D
Cylindrical axis	0~180°, Step size: 1°, 5°, 15°
Prismatic power	0~20△, Step size: 0.1△, 0.5△, 1△, 2△, 3△
Prism base	0~360°, Step size: 1°, 5°. Prim base can be marked horizontally or vertically.

## 1.3 Host

Product model: YPA-2100

Software version number: V3

Operating environment of the software:

Hardware configuration: the minimum configuration of a tablet computer (storage device: system memory not less than 4GB, storage capacity not less than 8GB; display screen: screen size not less than 8 inches, screen pixels not less than 3 million).

Software environment: Android operating system 7.0 and above, CPU/GPU: processor architecture ARM architecture.

Network conditions: CS architecture, local area network mode, bandwidth 2.4 GHz, WIFI wireless standard: 802.11 b/g/n.

### 1.3.1 Assistant lens

- a. Automatic crisscross cylinder: automatic crisscross cylinder  $\pm 0.25$ ,  $\pm 0.50$ D, separating lenses, one at left, one at right (the axle is self-rotatory);
- b. Fixed crisscross cylinder: fixed crisscross cylinder  $\pm 0.50$ D, one at left, one at right (the axle is fixed at  $90^\circ$ );
- c. Pinhole plate: hole diameter 1mm, one at left, one at right;
- d. Ross plate: used when setting pupil distance, one at left, one at right;
- e. Red and green optical filter: one is red optical filter (right) and one is green optical filter (left);
- f. Inear polarized optical filter:  $135^\circ$  right and  $45^\circ$  left;
- g. Maddox rod lens: right eye: red, horizontally, left eye: white, vertically;
- h. Sphere for retinoscopy:  $+1.5$ D and  $+2.0$ D, one at left, one at right;
- i. Decomposing prism: right eye:  $6\Delta$ BU, left eye:  $10\Delta$ BI

### 1.3.2 Adjustment range

- 1) Adjustment range of pupil distance: 48mm~82mm
- 2) Forehead base can be adjusted continuously; the adjustment range should reach at least 14mm;
- 3) Adjustable range of near vision optometry distance (distance of near-point rod): 350mm~700mm;
- 4) Corneal vertex marking: 12mm, 13.75mm, 16mm, 18mm and 20mm;
- 5) Horizontal adjustment:  $\pm 2.5^\circ$ .

### 1.4 Power parameters

Input voltage	AC 100V~240V( $\pm 10\%$ )
Input frequency	50/60 Hz
Input power	1.4-0.7A

### 1.5 Weight and Size

Weight	Host: about 3.8kg Printing base: about 0.8kg
Size	Host: 400mm (L) $\times$ 92mm (W) $\times$ 311mm (H) Printing base: 200mm (L) $\times$ 200mm (W) $\times$ 80mm (H)

\* The design and specifications are subject to changes due to technical updates without additional notice.

## 1.6 Principle

App is the user input controller and monitor, and the printing base provides WiFi. WiFi is used as the communication carrier between the host, the flat and the printing base to transmit data in the way of TCP.

- 1) The user sends the command through the app interface operation, and the host middle bridge receives the command analysis and distributes it to the left and right mirror plates for mirror plate positioning, so as to achieve the function of automatically adjusting and selecting the refractive lenses matching the examinee.
- 2) The user sends printing instructions through the operation of APP interface, and the printer starts printing after receiving the command resolution.

## 1.7 Name plate and indications

Name plate and indications are pasted on the instrument to arise end-users' notice.

In case the name plate is not pasted well or the characters become unclear to recognize, please contact authorized distributors.



The applied part of the device is Type B (the back side of digital refractor)



Refer to instruction manual/ booklet



Date of manufacture

**G.W.**

Gross Weight

**DIM.**

Dimension





Manufacturer



CE marking



Medical device



Correct Disposal of This Product (Waste Electrical & Electronic Equipment)



Serial number



Catalogue number



Unique Device Identifier



Model number



Consult instructions for use



Authorized European representative



Country of manufacture



Nonionizing radiation



Rotating Mark, + to increase distance, - to reduce distance



Rotating Mark, The thicker the line width, the stronger the locking force



Upside down rotating



D.C. 15V power input



D.C. 15V power output



Fragile, handle with care



This way up



Keep dry



Do not roll



Stacking limit by 5



The USB interface

WLAN The WLAN interface

LAN

The LAN interface



Temperature limit



Humidity limitation



Atmospheric pressure limitation

We will make available on request circuit diagrams, component part lists, descriptions, calibration instructions, or other information that will assist service personnel to repair those parts of ME equipment that are designated by the manufacturer as repairable by service personnel.

## 2. Safety Precautions



Please read the following matters needing attention carefully in case of personal injury, device damages or other possible hazards:

- Use the device indoors and keep it clean and dry; do not use it under inflammable, explosive, high fever and dusty environment.
- Do not use the device near water; also be careful not to make any kinds of liquid drop onto the device. Do not place the device in damp or dusty places, or places where humidity and temperature change quickly.
- Make sure the device host is stably and reliably installed before using it; fall of the device host may cause personal injury or device failure.
- Dedicated power adaptor configured for the device should be used: model GSM60A15 (component of device), Input 100V~240V~1.4-0.7A 50/60Hz, Output 15V 4.0A.
- Make sure the input voltage is consistent with rated input voltage and the electric wire is correctly

connected and well grounded (The device should be placed in a place that is prone to power outages).

- Do not use multi-pin socket or extend the power line to insert the plug of the device into power socket.
- Unplug power line and cut off power supply line especially under emergency circumstances; hold the power plug to pull out it from the socket rather than pulling the power cord.
- Do not touch the power line with wet hands. Check the power line and do not allow the power cord to be stamped, pressed by heavy objects or knotted.
- Power line damage may cause fire or electric shock. Please check it regularly.
- Before testing each patient, clean the contacting part with ethanol for disinfection.
- Cut off power and put on dust cover when not using it.
- Do not dismantle or touch the interior parts of the device, otherwise it may cause electric shock or device failure.
- The device has passed electromagnetic compatibility test. Follow below instructions related to EMC (electromagnetic compatibility) when mounting and using the device:
  - Do not use the device with other electronic devices to avoid electromagnetic disturbance.
  - Do not use the device nearby other electric devices to avoid electromagnetic disturbance.
  - Do not use a power adaptor that is not configured with the device, otherwise it may increase the electromagnetic emission , which may reduce the capacity of resisting disturbance.
- This product contains a wireless module. The wireless parameter specifications are as follows (transmit and receive):
  - Network conditions: CS structure, local area network mode.
  - Modulation type: 802.11b CCK; 802.11g OFDM; 802.11n MCS.
  - Channel bandwidth: 20MHz.
  - Recommended operating parameters: operating frequency: 160MHz, operating mode: 802.11b/g/n mixed operating mode.
- Requirements for wireless communication equipment
  - LCD visual chart produced by Chongqing Yeasn Science - Technology Co., Ltd.;
  - Other equipment requirements: support wireless network communication, the wireless transmission standard protocol must at least support 802.11b/g, and the wireless transmission power must not be

less than 5dBm; it must comply with the communication protocol of both parties.

- User access control mechanism:

- User identification method: After selecting the user type, verify it by entering a password.

- User type and permissions:

Demonstration user: No WIFI connection function permission, demonstration operation can be carried out after entering the password.

YPA users: have the permission of WIFI connection function, and can perform communication operations after entering the password.

Administrator user: Has YPA user permissions, binding access device permissions, and parameter control permissions.

- Password: The factory default is the administrator user, the initial password of the administrator user is yeasn8888, the initial password of the YPA user is ypa2100, and the initial password of the demo user is yeasn6666.

- This product is used in a local area network, and it is not recommended to connect to an external network to upgrade the system software.

- Notification: Any serious event related to the device to the user and/or patient shall be reported to the manufacturer and competent authority of the Member State where the user and/or patient is located.



Caution: The user is cautioned that changes or modifications not expressly approved by the party responsible for compliance could void the user's authority to operate the equipment.

This device complies with Part 15 of the FCC Rules. Operation is subject to the following two conditions: (1) this device may not cause harmful interference, and (2) this device must accept any interference received, including interference that may cause undesired operation.

NOTE: This equipment has been tested and found to comply with the limits for a Class B digital device, pursuant to Part 15 of the FCC Rules. These limits are designed to provide reasonable protection against harmful interference in a residential installation. This equipment generates uses and can radiate radio frequency energy and, if not installed and used in accordance with the instructions, may cause harmful interference to radio communications. However, there is no guarantee that interference will not occur in a particular installation.

If this equipment does cause harmful interference to radio or television reception, which can be

determined by turning the equipment off and on, the user is encouraged to try to correct the interference by one or more of the following measures:

- Reorient or relocate the receiving antenna.
- Increase the separation between the equipment and receiver.
- Connect the equipment into an outlet on a circuit different from that to which the receiver is connected.
- Consult the dealer or an experienced radio/TV technician for help.

FCC Radiation Exposure Statement:

This equipment complies with FCC radiation exposure limits set forth for an uncontrolled environment. This equipment should be installed and operated with a minimum distance of 20cm between the radiator and your body.

This transmitter must not be co-located or operating in conjunction with any other antenna or transmitter.

End user must follow the specific operating instructions for satisfying RF exposure compliance.

The portable device is designed to meet the requirements for exposure to radio waves established by the Federal Communications Commission (USA). These requirements set a SAR limit of 1.6 W/kg averaged over one gram of tissue. The highest SAR value reported under this standard during product certification for use when properly worn on the body.

### 3. Main Structure

#### 3.1 Host

##### 3.1.1 Front side (tester side)

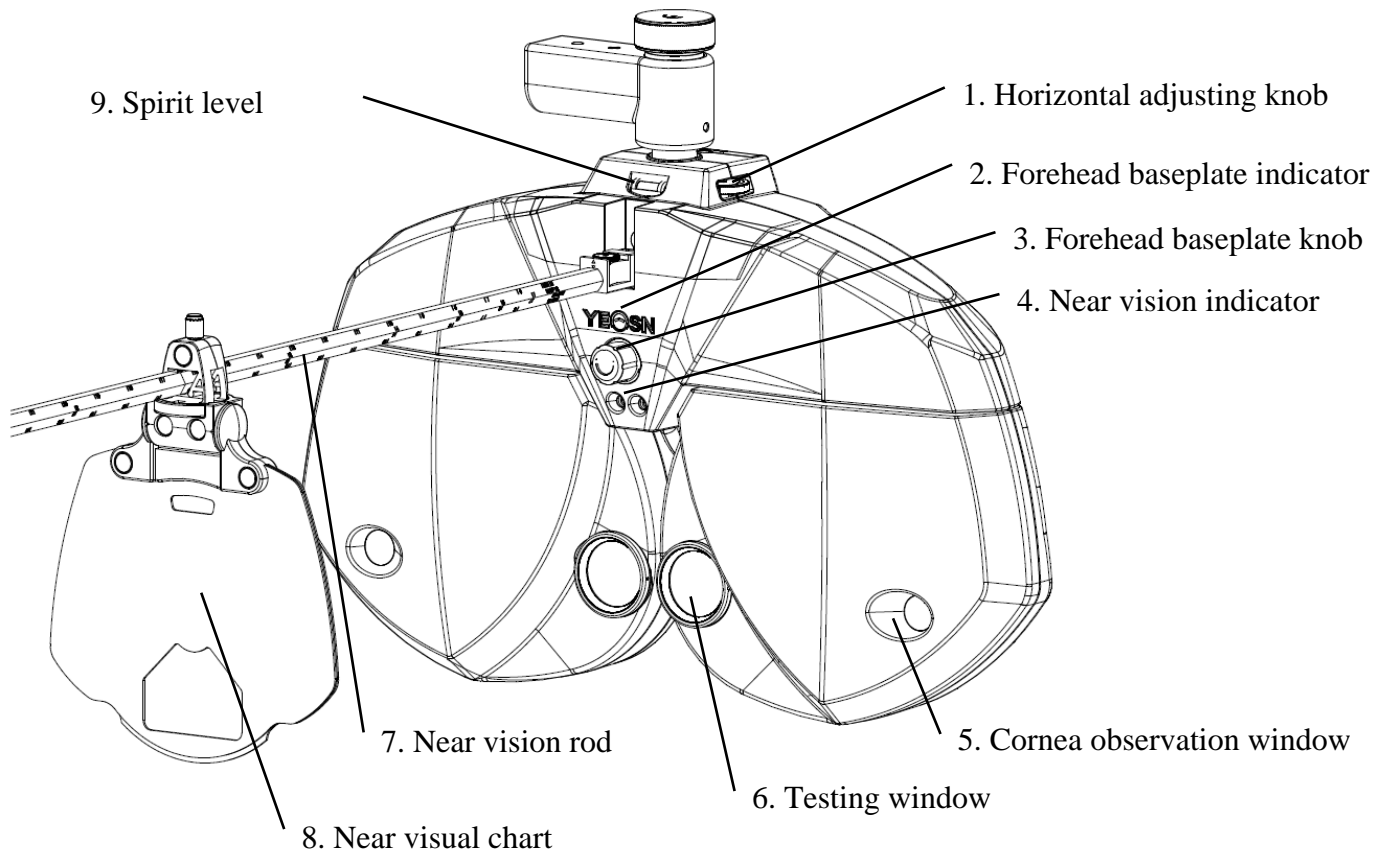

##### 3.1.2 Back side (testee side)

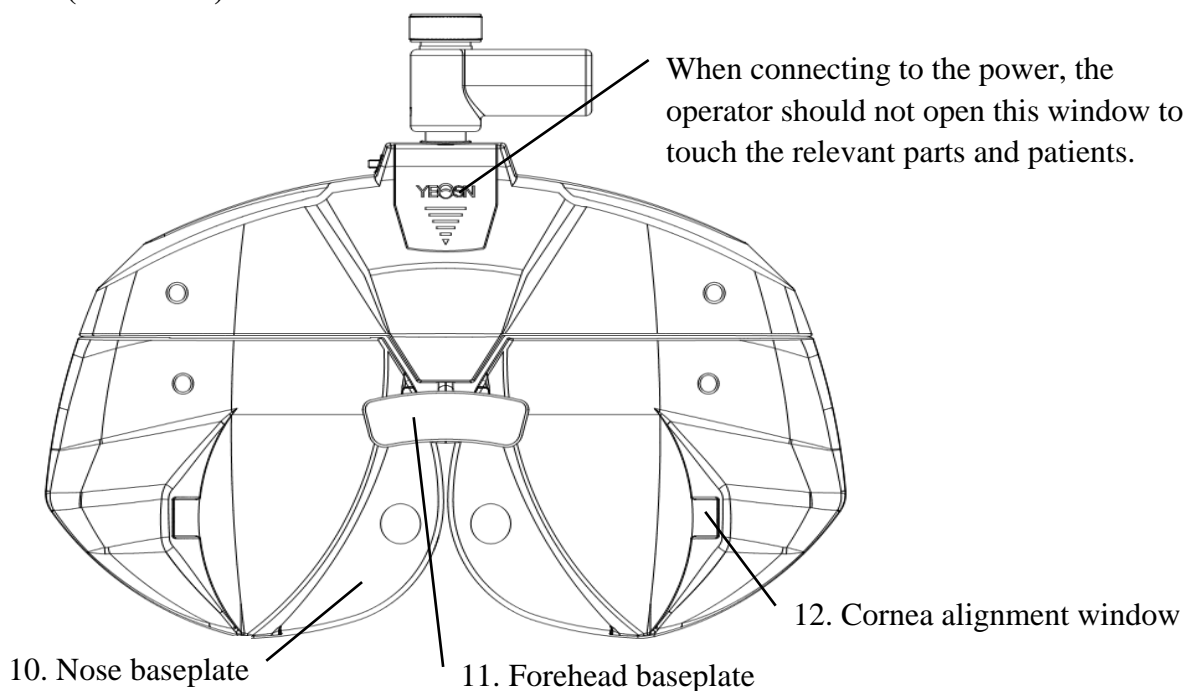

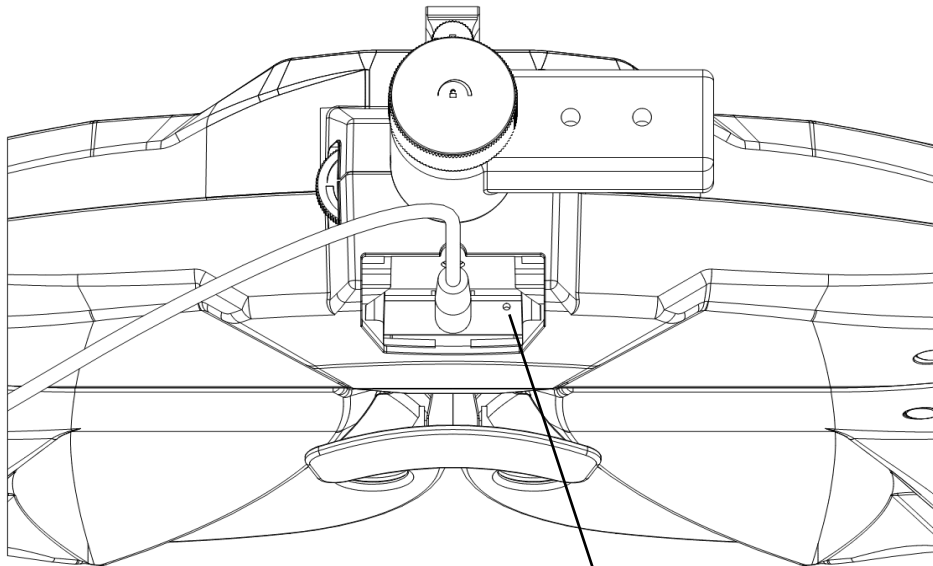

13. Resetting button

1. Horizontal adjusting knob

Adjust the horizontal level of the vision tester.

2. Forehead baseplate indicator

Make sure the forehead of the testee contact the baseplate. The indicator is always on when the forehead doesn't contact the baseplate; the indicator is off when the forehead contacts the baseplate.

3. Forehead baseplate knob

Adjust the distance of the testee's corneal vertex

4. Near vision indicator

Light up short-distance visual chart during short-distance test.

5. Cornea observation window



Observation distance should be 200 mm-250mm. The windows through which to observe and confirm the distance of the testee's corneal vertex.

6. Testing window

Light aperture for testing.

7. Near vision rod

Install and support the near visual chart.

8. Near visual chart

For testing near vision.

9. Spirit level

Confirm the horizontal location of the vision tester. Rotate the horizontal adjusting knob to keep the

air bubble in the spirit level in the middle.

#### 10. Nose baseplate

The nose or face of the testee may contact the nose baseplate during vision test. Clean this part before every time of vision test.

#### 11. Forehead baseplate

The forehead of the testee may contact the forehead baseplate during vision test. Clean this part before every time of vision test.

#### 12. Cornea aiming window

Shows the alignment position of the testee's corneal vertex.

#### 13. Resetting button

Set the main device to factory default settings by pressing and holding resetting button for 5 - 10 seconds.

### 3.2 Printing base

#### 3.2.1 Front

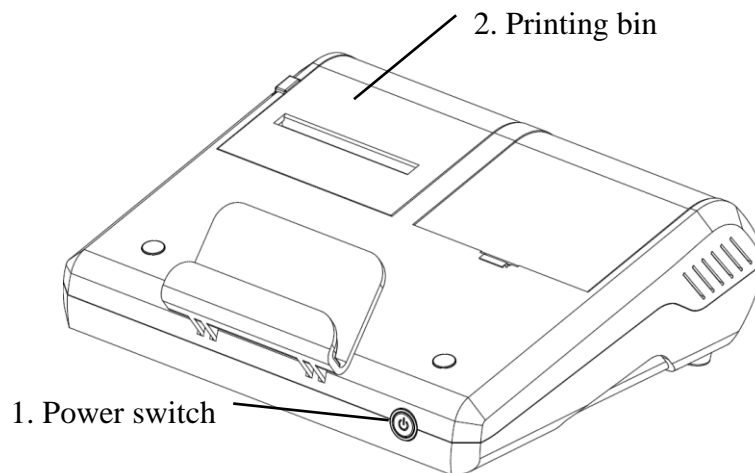

#### 3.2.2 Back

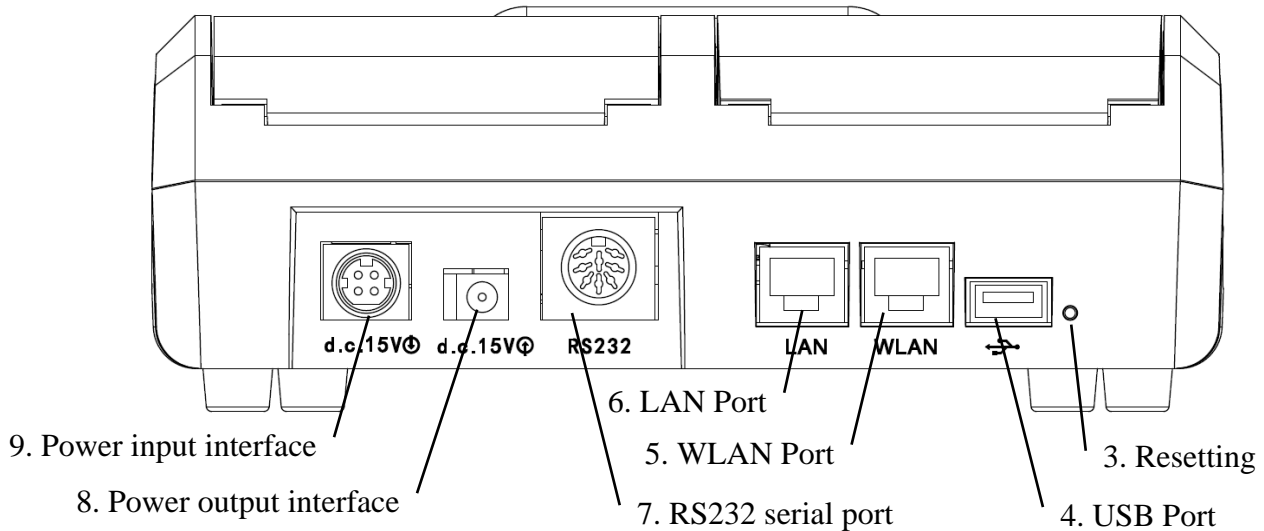



1. Power switch

Turn on power switch; power indicator is lit up.

2. Printing bin

Install printing papers.

3. Resetting button

Press and hold resetting button for 5-10 seconds and factory default settings of printer are restored.

4. USB Port

It is used for connecting and charging pad (output 5V1A).

5. WLAN Port

It is used for internet communication. Communication cable is less than 1 meter.

6. LAN Port

Reserved for manufacturers and designated distributors to configure routers before sale. The length of the communication line is less than 1m.

7. R232 serial port

Reserved for software updating by manufacturers and assigned distributors, the communication cable length is less than 1m.

8. Power output interface

Connect to the power input interface of the host.

9. Power input interface

Connect to the output interface of the power adapter.

Note:

USB Port, W LAN Port and LAN Port Jack Area section to desk 60601-1, 60950-1 type Equipped.

USB Ports can also be U disk.

## 4. Installation Method

### 4.1 Part List

Digital refractor	1Set	
Printing base	1Pc	
Near Vision Chart	1Pc	
Near Vision Rod	2Pcs (1Pc 40cm, 1Pc 30cm)	
Power adaptor	1Pc	
Dust cover	1Pc	
Blowing balloon with brush	1Pc	
Printing paper	2Rolls	
Power Cord	1Pc	
DC power cord	1Pc	
Hex wrench (1.5mm)	1Pc	
Hex wrench (2.0mm)	1Pc	
Hex wrench (2.5mm)	1Pc	
Hex wrench (3mm)	1Pc	
Screw	4Pcs (2Pcs for Near Vision Rod)	
Lens scrubbing cloth	1Pc	
Magnetic induction patch (Used to fix the flat plate on the printing base)		1Pc

Note: Detachable parts: adaptor.

Accessory: Near Vision Chart.

### 4.2 Installation Instructions

#### 4.2.1 Install the device onto the compound table

Take out 3 Pcs Stainless steel flat head set screw(M6×8), and then please refer to compound table manual, YPA-2100 DC Line maximum diameter is 11mm.

Please select the suitable compound table before installation as follows.

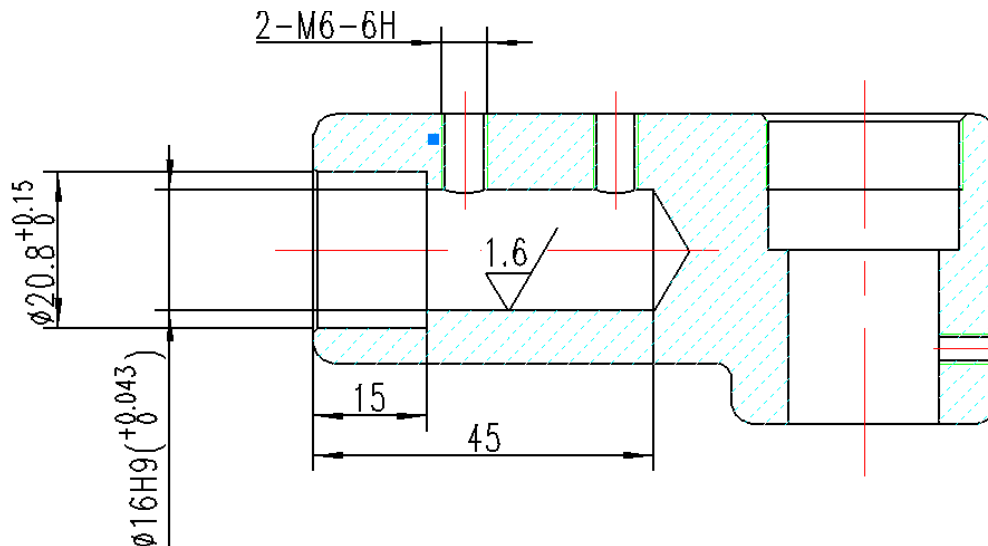

#### 4.2.2 Install near visual chart

Insert the card tray of the visual chart into the near vision rod and screw the knob tight. The card tray can slide on the rod and rotate 360°.

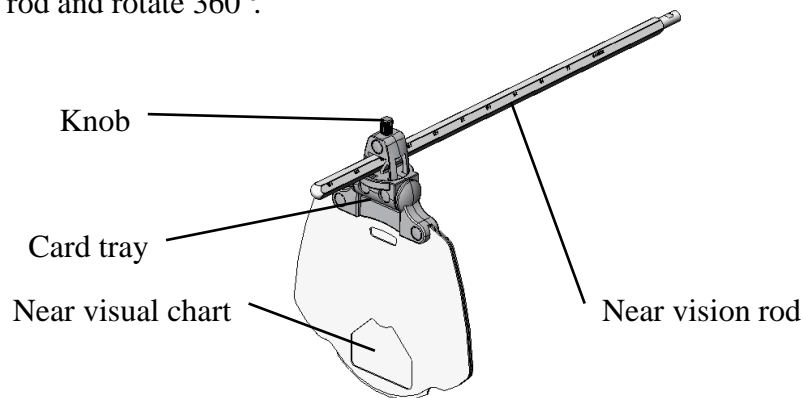

#### 4.2.3 Install near vision rod

Insert the vision rod into the installation hole in the vision tester host and screw the knob.

Attention during installation: align the flute on the vision rod at the knob and keep the end of the vision rod close to the end of the installation hole in the vision tester host.

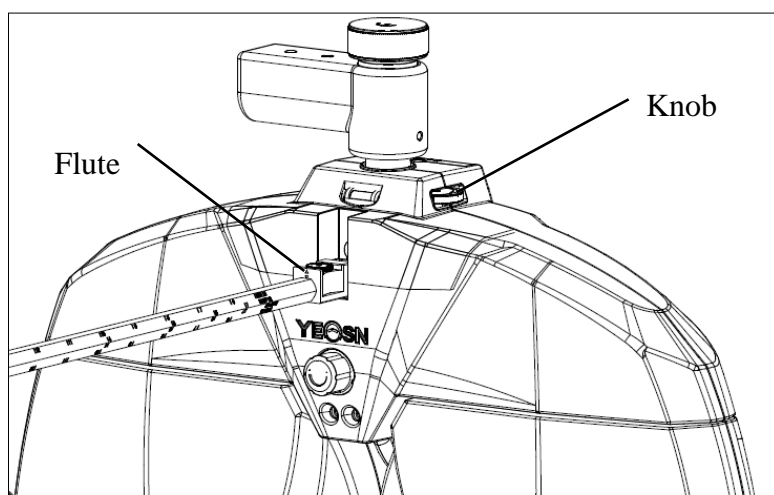

#### 4.2.4 Horizontal adjustment after installation

Rotate the horizontal adjusting knob until the air bubble in the spirit level in the middle.

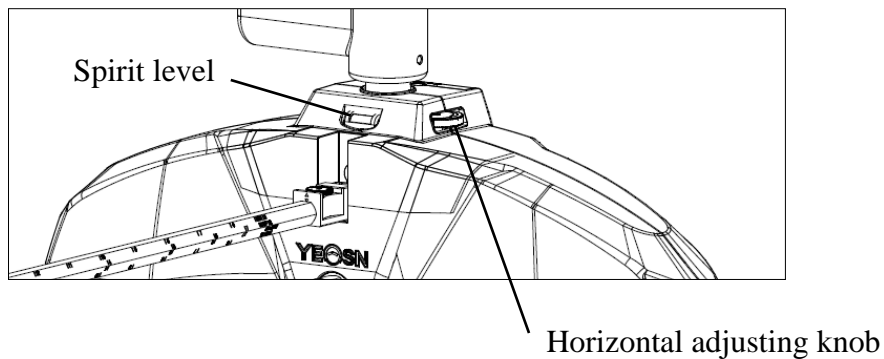

#### 4.2.5 Install printing paper

Please refer to “Replace printing paper” (see 9.1).

#### 4.2.6 Install APP

- 1) Please contact the dealer to download the dedicated APP
- 2) Install the APP pad recommendation: **Samsung** or **Huawei** no less than 8-inch Android pad.  
Android operating system: version 7.0 and above.CPU/GPU: processor architecture ARM



If you use other pad, fonts and images may be mismatched.

- 3) Connect the tablet WIFI to the router with "**SSID: yeasn\_XXXXXX**", Password: **yeasn2002**.

- 4) Wireless connection of PAD to the main device

- a. Ensure WIFI on PAD is turned on, location based service is also turned on and APP is authorized when installing it.

- b. Log into APP on PAD as administrator. Tap the upper right  , enter devices list and tap “add the device ” , select YPA-2100 digital refractor icon.

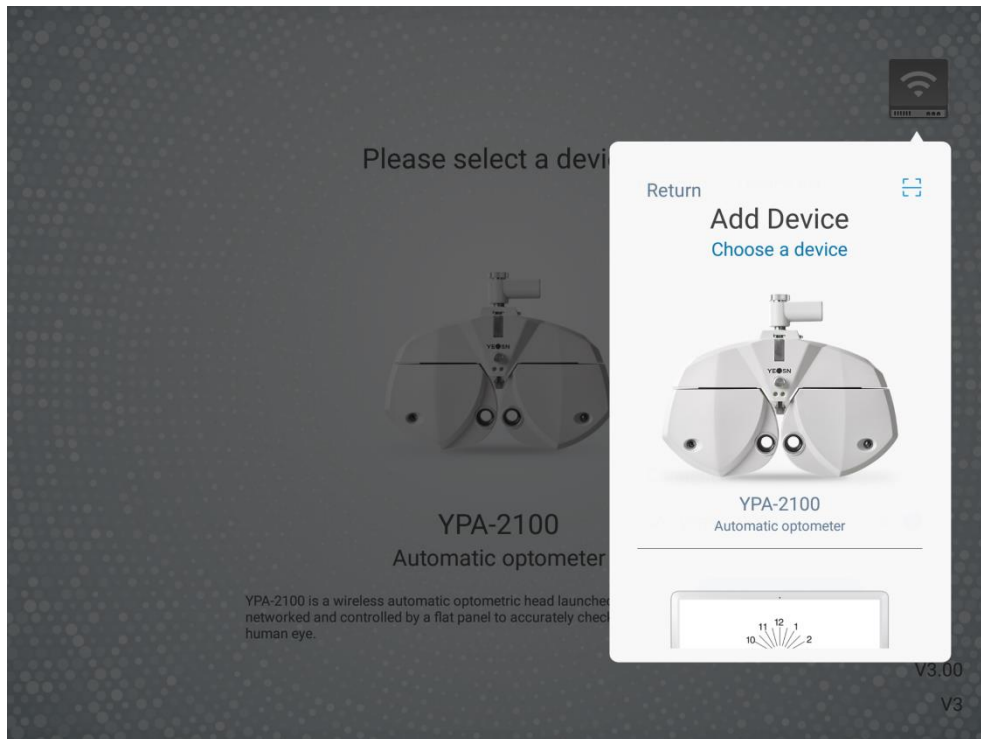

c. Tap “next step” and perform resettings according to the tips.

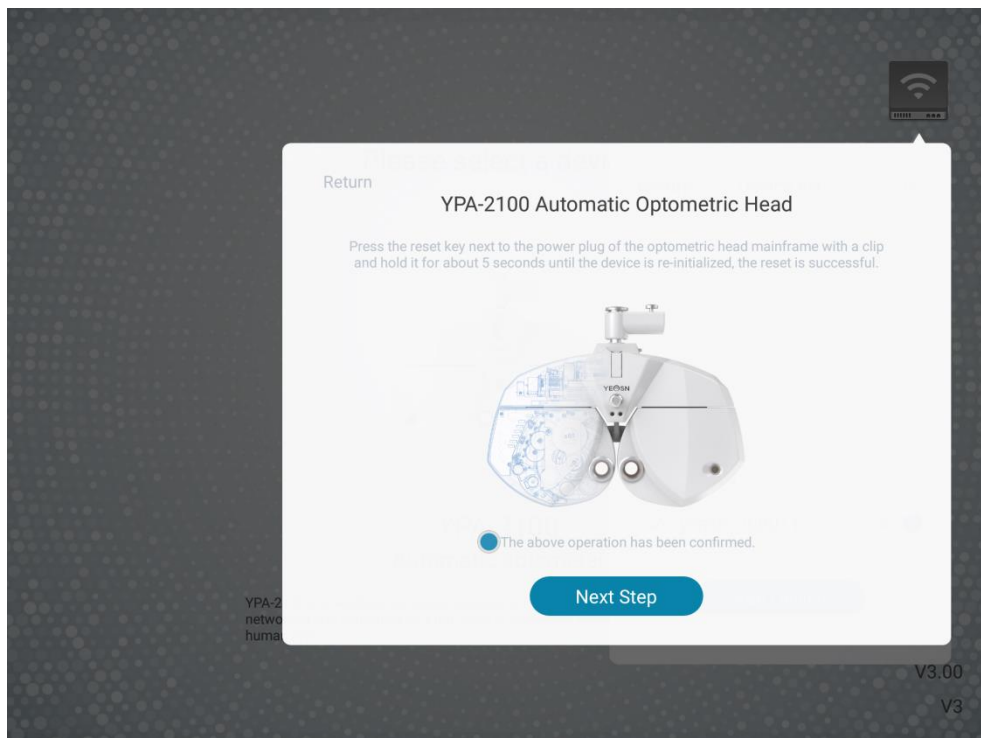

d. Select the WIFI network of product YPA-2100, enter WIFI password for connection. Then tap “next step”. As shown in the picture yeasn\_000001 below, connection to yeasn\_000001 is completed.

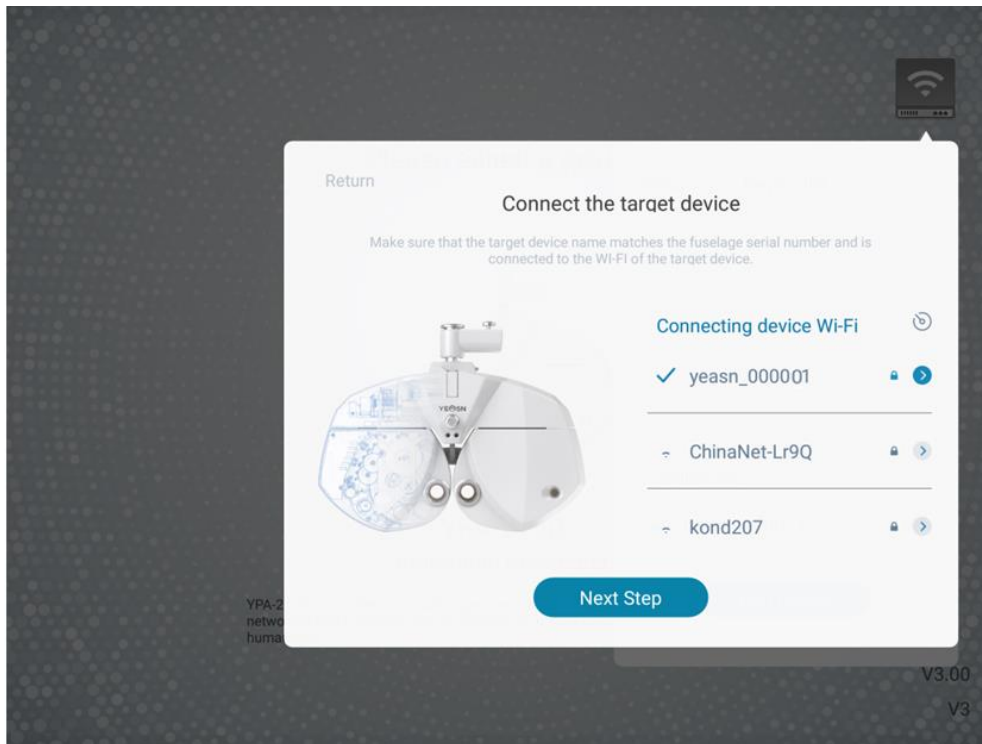

e. Select the router you need to connect to or WIFI signal of the printing box and enter password in the password field. Enter the required IP address in IP address field and enter the corresponding port number and click “next step” (when setting a single set of device the default configuration is being used, just click “next step”) and continue the configuration until the network connection to YPA main device is completed.

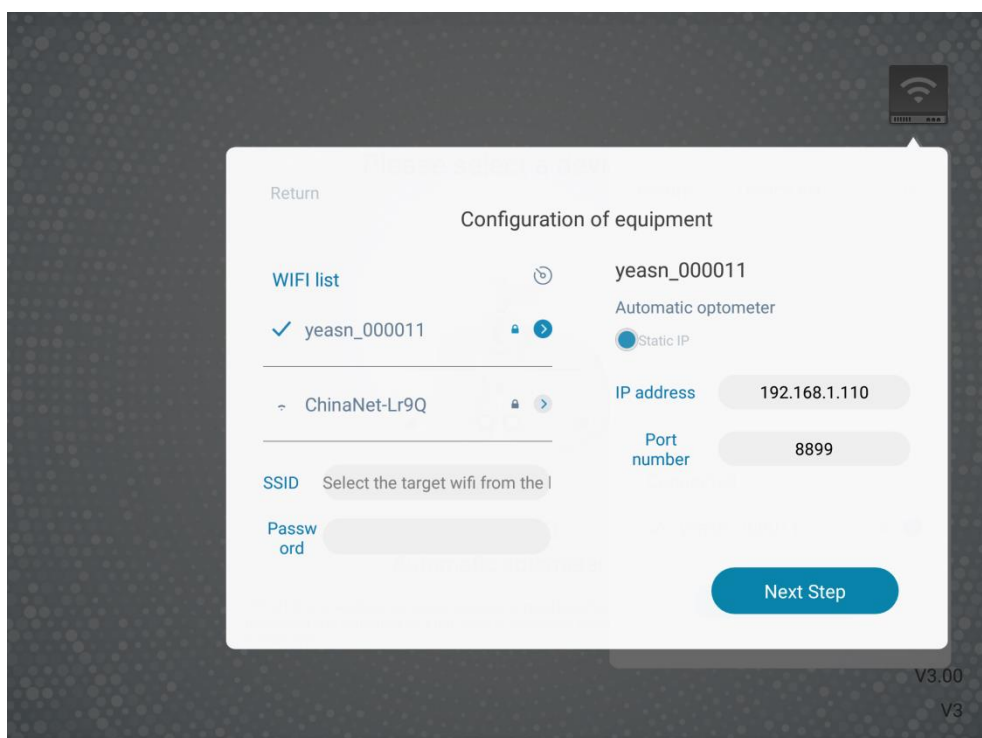

## **5. Preventive inspection**

The equipment should be inspected preventively before use.

### **5.1 Device startup**

1) Insert the power plug into the socket.

The power adaptor configured with the device is three-pin plug, please select suitable power socket

Note: please use dedicated power line configured with the device.

2) Press the power switch on the printing base, the power indicator is on

### **5.2 Inspection**

1) The measurement window should be clean.

2) The equipment is in a horizontal position.

3) The lenses and accessories are fixed in front of the detection window, and the instrument should be aligned and centered.

### **5.3 Inspection cycle: before use every day**

## **6. Directions for Use**

### **6.1 Device Startup and Shutdown**

#### **6.1.1 Device startup**

1) Insert the power plug into the socket.

The power adaptor configured with the device is three-pin plug, please select suitable power socket.

Note: please use dedicated power line configured with the device.

2) Start up the host first: press the power switch on the printing base, the power indicator is on.

3) After the host is initialized, start up the compound laptop and open the operation interface.

#### **6.1.2 Device shutdown**

1) Press the power switch on the printing base to turn off the device, the power indicator is off.

2) Put the dust cover on the host.

#### **6.1.3 Illumination requirements of the environment during daily use**

The lighting in the optometry room should be slightly dark and soft, and no stray light is allowed to stimulate the eyes of the examinee; the lighting in the optometry room can generally be 40W~60W milky incandescent lamps, the illuminance is adjustable, and when using the optometry head,

generally open 1 to 2 lamps.

## 6.2 Operation Interface

### 6.2.1 Main interface

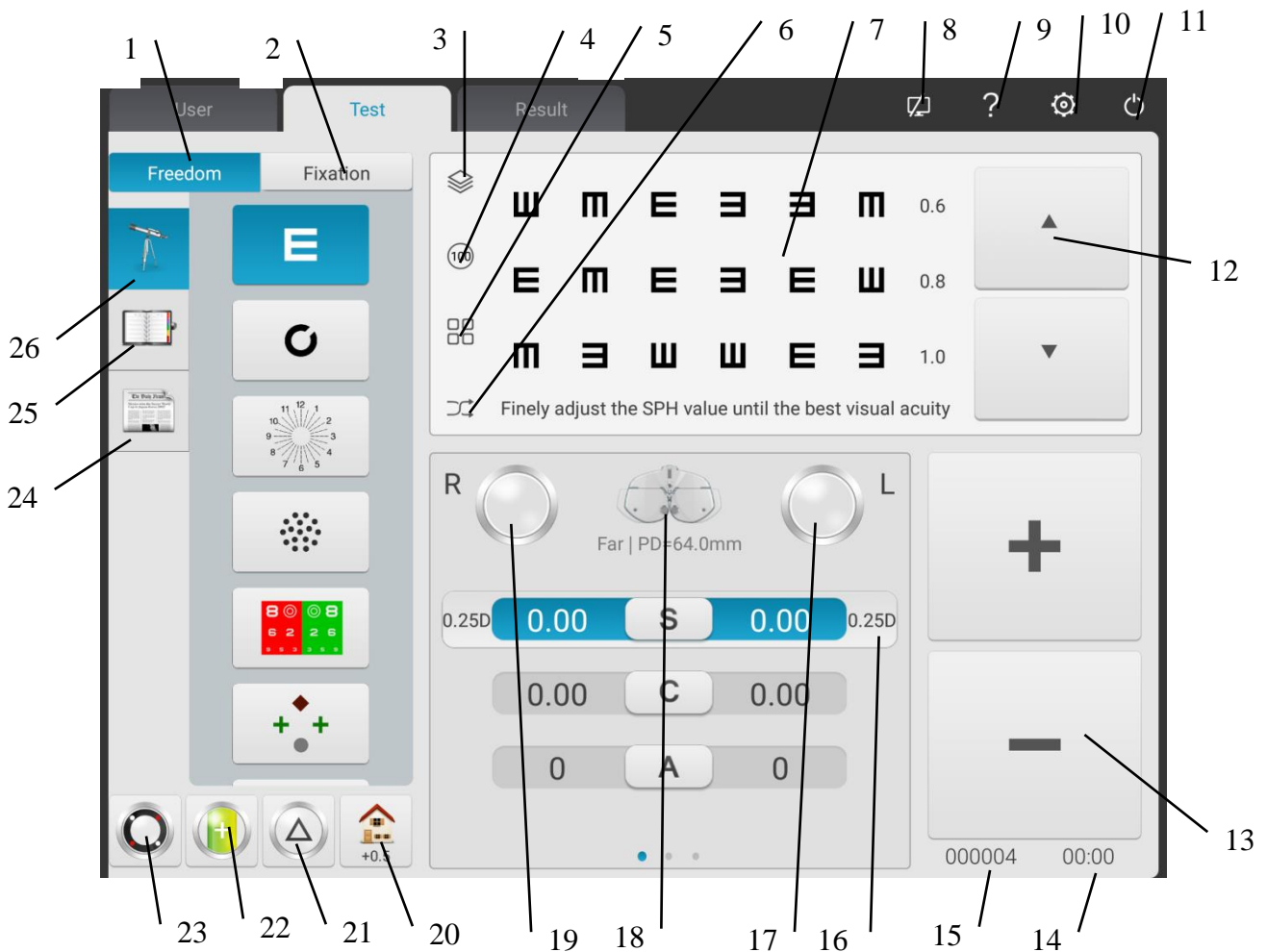

1. Free mode

Operators select sighting marks to perform optometry according to their preferences.

2. Procedure

Display current procedure.

3. Red green background/black and white color inverting

Red green color background can be selected. Black white color inverting in terms of sighting mark colors also can be quickly adjusted.

4. Contrast adjustment

Adjust contrast of sighting marks

5. Display mode of sighting marks

It can be single unit, single line, single row, full screen and ETDRS.



## 6. Random

Sighting marks appear randomly.

## 7. Display area of sighting marks

Display selected sighting marks with optometric tipping words at the bottom when performing optometry.

## 8. Connection state indication

Indicate network connection state to LCD display chart YPB-2100.

## 9. Sighting mark assistance

Display names, functions and using methods of sighting marks.

## 10. Parameters settings

After tapping it enter the parameters settings interface.

## 11. Exit

Exit operating program system.

## 12. Scroll display of sighting marks

Scrollable single-unit, single-line, single-row and full-screen display of sighting marks can be realized by pressing up and down buttons.

## 13. +, -

Data increase and decrease can be realized by pressing S\C\A\ADD\BIBO\BDBU.

## 14. Operation time

Display the time spent from beginning to the end.

## 15. Test number

## 16. Quick change of optometric step length

Optometric step length can be quickly changed by pressing S\C\A\BIBO\BDBU.

## 17. Left auxiliary disc lenses

Click this key to popup the choice box related to left auxiliary lenses.

## 18. Measurement mode

Distance: distance mode, Near: near mode.

Distance mode and near mode can be switched to each other by pressing “distance mode” or “near mode”.

## 19. Right auxiliary lenses

Click this key to popup the choice box related to right auxiliary lenses.

#### 20. Quick setting

When S is positioned, a shortcut to blurred vision appears.

When C is positioned, a shortcut to equivalent spherical lens appears.

When A is positioned, a shortcut to axis angle of cylindrical lens appears.

When BIBO or BDBU is positioned, a shortcut to prism display mode switch appears.

When ADD is positioned, a shortcut to vision near light appears. It can be selected off or on.

#### 21. Prism lens removal/setting

By pressing this key set and remove prism lens in the testing window.

#### 22. Cylindrical lens -/+

It is used for positive and negative exchange of cylindrical lens.

#### 23. Cross cylindrical lens

By pressing this key set and remove cross cylindrical lens in the testing window.

#### 24. Sighting marks 2

Select and display sighting marks, including near-point sighting marks, color blindness sighting marks and contrast sensitivity sighting marks.

#### 25. Quick testing

Support divergence testing, convergence testing and near-point convergence testing (near-point convergence, near-point adjustment, negative relative adjustment, positive relative adjustment) and other functions.

## 26. Sighting mark 1

Select and display sighting marks, including vision sighting marks and functional sighting marks.

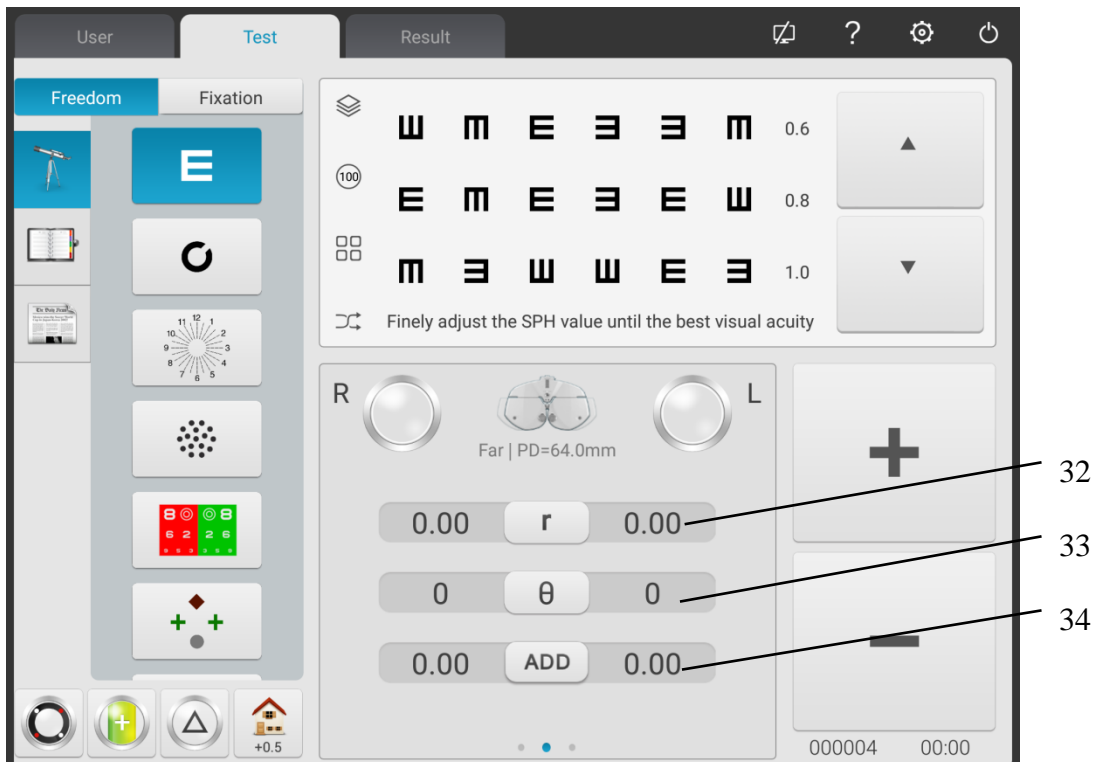
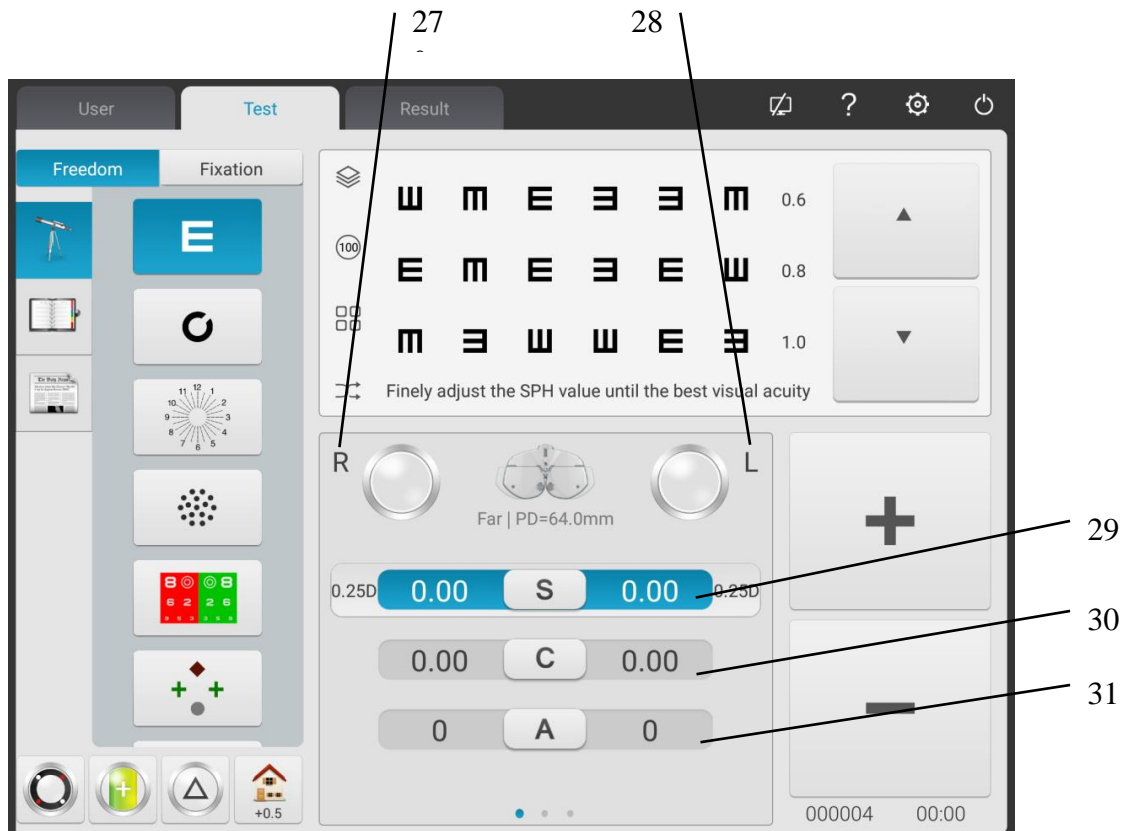



27. R

Right testing window, input right eye data and select right eye as the dominant eye.

28. L

Left testing window, input left eye data and select left eye as the dominant eye.

29. S

Spherical power input window

Press S input window aside R to input the spherical power of right eye; press S input window aside L to input the spherical power of left eye.

30. C

Cylindrical power input window

Press C input window aside R to input the cylindrical power of right eye; press C input window aside L to input the cylindrical power of left eye.

31. A

Cylindrical axis input window

Press A input window aside R to input the cylindrical axis of right eye; press A input window aside L to input the cylindrical axis of left eye.

32. r

Prismatic power input window

Press r input window aside R to input the prismatic axis of right eye; press r input window aside L to input the prismatic axis of left eye.

33.  $\theta$

Prism base input window

Press input window aside R to input the prism base of right eye; press input window aside L to input the prism base of left eye.

34. ADD

Additional power input window

Press ADD input window aside R to input the additional power of right eye; press ADD input window aside L to input the additional power of left eye.

35. VA

VA input window

Press VA input window aside R to input the power of right eye; press VA input window aside L to input the power of left eye.

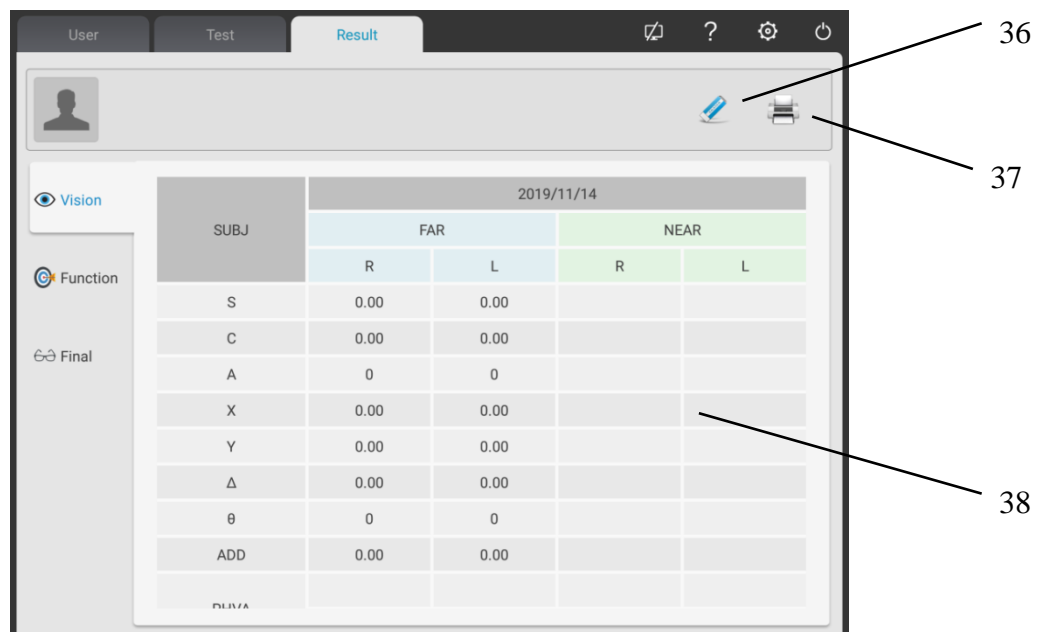

36. Clear

Clear all optometry data of current patient on the interface (including the foreground);

37. Print

It can choose the needed data to print out

It can choose: UNA, LM, AR, SUBJ, FINAL, Function;

38. Slide the data bar left and right to query the patients historical optometry data.

Visual function interface: Displays the visual function test result of the device.

Function		2021/07/13	
		Measured value	Normal value
Worth 4			
Stereo Check			
H.A			OK/NG
V.A			OK/NG
Dominant Eye			R/L
Far H.P			B01~B13
Far Div	Fuzzy		
	Crack		B15~B19
	Recovery		B13~B15
	Fuzzy		B07~B011

Prescription interface: According to the results of the try-on, the optometrist manually adjusts and enters the final optics data in the prescription interface.

Final	2021/07/13			
	FAR		NEAR	
	R	L	R	L
S	0.00	0.00	0.00	0.00
C	0.00	0.00	0.00	0.00
A	0	0	0	0
X	0.00	0.00	0.00	0.00
Y	0.00	0.00	0.00	0.00
Δ	0.00	0.00	0.00	0.00
θ	0	0	0	0
ADD1	0.00	0.00		
ADD2				

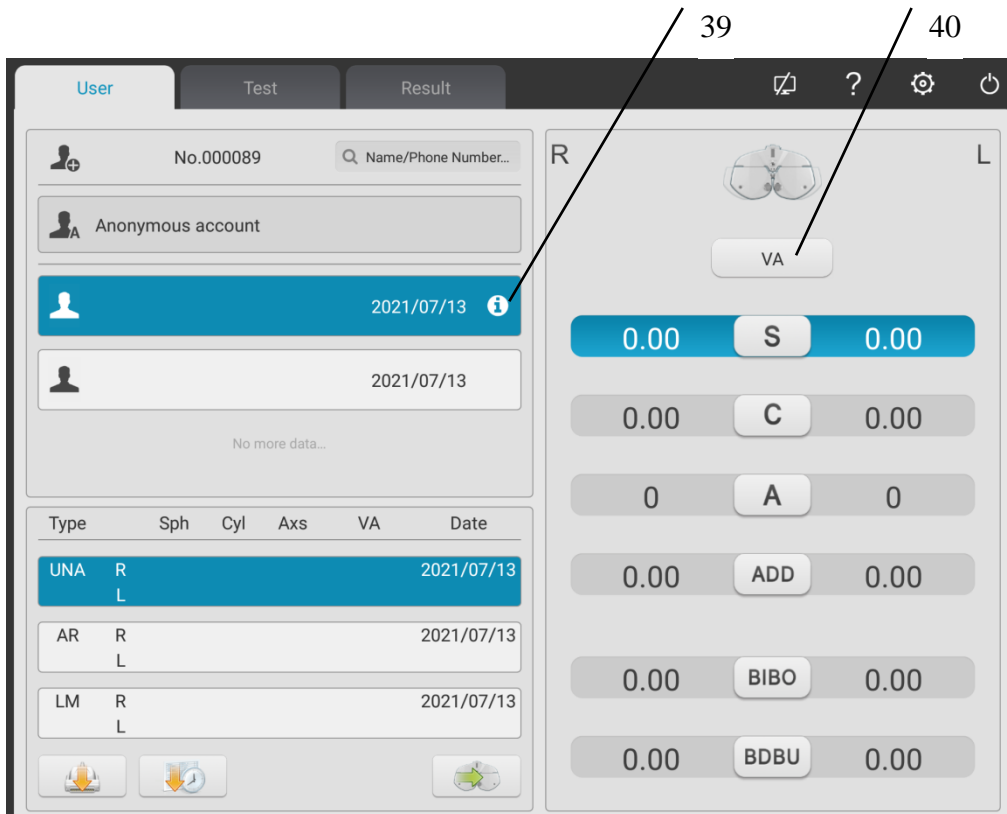

### 39. Patient age input

Click this button to enter the age of the patient, and the ADD value will be automatically placed.

### 40. VA adjustment

Press the UNA column and click the VA adjustment button to enter the UNA naked eye value.

Press the AR column and click the VA adjustment key to enter the value of AR vision.

Press the LM column and click the VA adjustment key to enter the value of LM vision (eyesight with glasses).

## 6.2.2 Assistant lens setup

1. Press “Assistant lens” key to display assistant lens interface.
2. Press corresponding keys in the interface to. The selected assistant lens will be called in the testing window and return to testing interface automatically.

Popup display interface after tapping left assistant lens

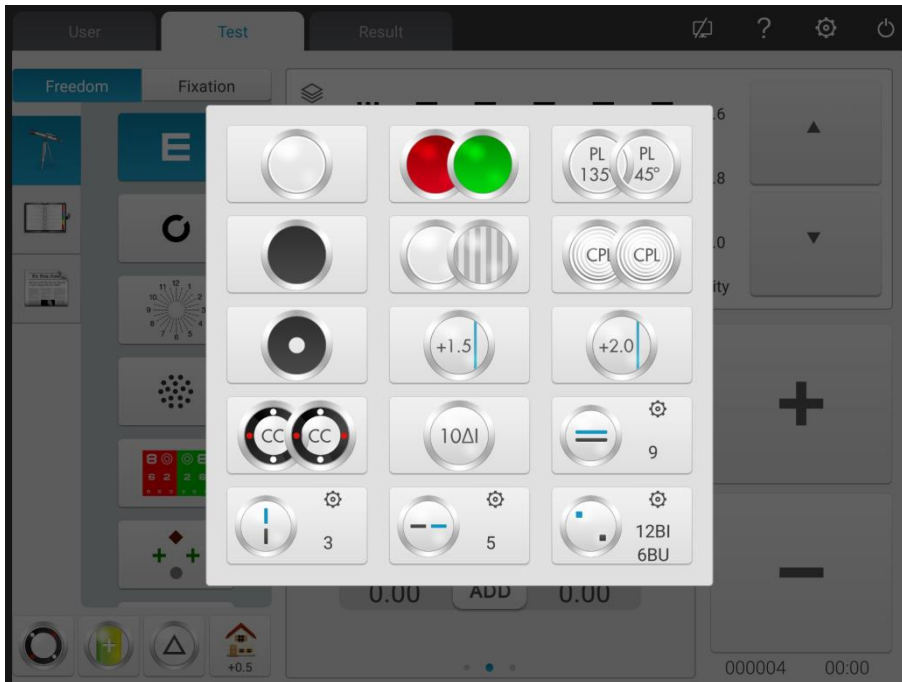

Popup display interface after tapping right assistant lens





Key functions are described as follows.



Open testing window



Baffle plate, shelter testing window



Pinhole plate (hole diameter 1mm)



Right eye: red optical filter, left eye: green optical filter



Right eye: 135° polarized optical filter, left eye: 45° polarized optical filter



Right eye: fixed crisscross cylinder, left eye: fixed crisscross cylinder



Right eye: horizontal Maddox rod, left eye: open testing window



Right eye: open testing window, left eye: vertical Maddox rod



Retinoscopy lens, 1.50D and 2.0D optional



Binocular equilibrium prism, press  to change prismatic power



Horizontal heterophoria prism, press  to change prismatic power



Vertical heterophoria prism, press  to change prismatic power



Right eye: 6△ base-upward prism



Left eye: 10△ base-inward prism



Left eye: base-upward prism, Right eye: base-inward prism, press  to change prismatic power

### 6.2.3 Pupil distance input



1. Pressing key, PD adjusting lens is called into the testing window.

The factory default PD value is 64.0.

2. Click the data frame to be changed and input pupil distance.

Input left eye PD, binocular PD and right eye PD respectively.

Press “+” to enlarge PD, press “-” to reduce PD.

3. By tapping any position beyond PD entering interface, exit PD entering interface.

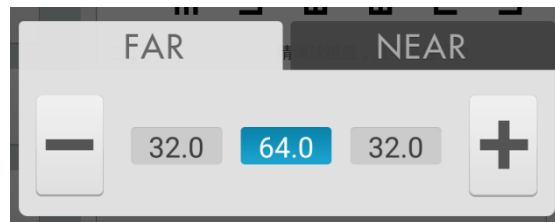

### 6.2.4 System parameter setup

1. Press  to enter system parameter setup interface

2. Select needed parameter to change parameter setup.

3. After completing all the settings press  and go back to the upper level.

**Detailed parameters settings are described as follows.**

1. Step length

- S: 0.12D, 0.25D, 0.5D, 1D, 2D, 3D; Factory setting: 0.25D

Set the step length of spherical power and select from 0.12D, 0.25D, 0.5D, 1D, 2D and 3D.

- C: 0.25D, 0.5D, 1D; Factory setting: 0.25D

Set the step length of cylindrical power and select from 0.25D, 0.5D and 1D.

- A: 1°, 5°, 15°; Factory setting: 5°

Set the step length of axis angle of cylindrical power and select from 1°, 5° and 15°.

- $\Delta$ : 0.1 $\Delta$ , 0.5 $\Delta$ , 1 $\Delta$ , 2 $\Delta$ , 3 $\Delta$ ; Factory setting: 0.5 $\Delta$

Set the step length of prism power and select from 0.1 $\Delta$ , 0.5 $\Delta$ , 1 $\Delta$ , 2 $\Delta$  and 3 $\Delta$ .

- $\theta$ : 1°, 5°; Factory setting: 5°

Set the step length of basal angle of prism lens and select from 1° and 5°.

2. Lens type

- XC type:  $\pm 0.25D$ ,  $\pm 0.50D$ , separation;

Factory setting:  $\pm 0.25D$

Set the cross cylindrical lens, which is put in the testing window and select from  $\pm 0.25D$ ,  $\pm 0.50D$  and separating prism lens.

- XC+ covering slice: on and off. Factory setting: off.

Set whether to enable blocking slice when changing crisscross cylindrical lens surfaces 1 and 2.

Set it on, add the blocking slice.

Set it off, disable the blocking slice.

- S.E.Fix: only crisscross cylindrical lens, only cylindrical lens, on, off; factory default: only crisscross cylindrical lens.

Only crisscross cylindrical lens: only when C is increasing by each 0.25D, s is decreasing by 0.12D.

Without crisscross cylindrical lens adjusting C does not result in changing S.

Only cylindrical lens: only when C is increasing by each 0.25D, s is decreasing by 0.12D. With crisscross cylindrical lens adjusting C does not result in changing S.

On: Regardless of crisscross cylindrical lens or cylindrical lens, changes are equivalent.

Off: Changes will not be equivalent.

- Binocular balance blurred vision: automatical, 0.25D, 0.50D, 0.75D, off.

Factory setting: automatical.

Call in binocular balance sighting mark and add blurred vision amount in accordance with settings.

- Red green balance blurred vision: 0.25D, 0.50D, off. Factory setting: off.

Call in red green sighting mark and add blurred vision amount in accordance with settings.

- CYL expression method: +, -;

Factory setting: -

Set entering method of cylindrical lens power.

When setting it “-” only enter negative cylindrical lens power.

When setting it “+” only enter positive cylindrical lens power.

- Prism lens expression method: X/Y, r/θ;

Factory setting: X/Y

Operator can select rectangular coordinates (X/Y) or polar coordinates(r/θ).

### 3. short-distance

- Short-distance indicator: on, except grid, off. Factory setting: off.

When it is set to on: in ADD mode and short-distance mode the indicator will be on automatically.

Except grid: the short-distance indicator is automatically on during ADD mode and short-distance mode. When choosing cross grid sighting mark for short-distance testing, the short-distance indicator is off.

When it is set to “Off”: the short-distance indicator is not automatically on. Turn it on by pressing the short-distance indicator button.

- Short-distance indicator brightness: low, intermediate, high. Factory setting: intermediate.

- F → N Link: SPH, SPH+ADD; factory default: SPH+ADD

Set the spherical value shifting from long-distance mode to short-distance mode.

SPH: the spherical value in long-distance mode is used in short-distance mode.

SPH+ADD: the additional power is added to the spherical value in the long-distance mode.

- ADD Estimation: on, off; factory default: on

Set if pre-add additional power according to the age of the patient during short-distance vision test.

- Working Distance: 35cm and 70cm, step length: 5cm. factory default: 40cm

#### 4. Printing

- Date printing format: month-date-year, date-month-year, year-month-date. Factory setting: month-date-year.

Set printing data format.

- Clear data after printing: on and off. Factory setting: off.

Set whether to clear measured data after printing.

- Printer: on and off. Factory setting: on.

When setting it to off: by pressing printing the data will be sent to the network. Printer doesn't work.

- Prism lens printing: on and off. Factory setting: off.

When setting it to on, enable printing prism lens power

When setting it to off, disable printing prism lens power.

#### 5. sighting marks

Select and display sighting marks, including sighting marks of near-point and distance-point.

#### 6. Communication

- AR data: on and off. Factory setting: on.

It is used to determine whether to automatically receive the data from computer refractor. On: automatic receiving external data.

- AR data processing:  $C \leq 0.25D$ ,  $C=0$ ,  $C \leq 0.50D$ ,  $C=0$ , off.

Factory setting:  $C \leq 0.25D$ ,  $C=0$

When AR cylindrical lens power is not more than 0.25D, reset the imported value C.

When it is set off, don't reset the imported value C.

- Data LM: on and off. Factory setting: on.

It is used to determine whether to automatically receive the data from focimeter. On: automatically receive data.

- Receive prism lens data from LM: on and off. Factory setting: off.

When importing data from focimeter set whether to automatically enter prism lens power data.

## 7. System

- Lens reset: fast, reset. Factory settings: fast.

Fast: return lens to zero and send the signal of returning lens to zero.

Reset: reset the main device and send resetting signal to main device.

- "Clean" tip: on and off. Factory settings: off.

When it is turned on, press button "clean" and pop-up appears with tips "Please confirm whether to clean the data. Yes or No".

By setting the parameter "on" operator can protect the data from deletion due to accident pressing button "clean".

- Sighting marks link: on and off. Factory setting: on.

When performing optometric testing avoid calling in the assistant lens or mode resulting from the corresponding sighting mark.

When setting is "on", after pressing sighting mark S, C, A, X, Y maintain the current status and the assistant disk condition remains unchanged.

- Sound: off and on. Factory settings: on.

Off: no vibration or audio tips.

On: realize function only under +-

- Operation time: on and off. Factory setting: on.

Set whether to display the testing time.

By setting “on” it will display the time from the beginning of the tests to the end.

- Security: change password, forget password
- User: user switch and factory settings restoration
- Hall data: hardware inspection. Assistant after-sales maintenance.
- Address: enter the optical shop address

## 8. About

- About

Display system information (including software version and manufacture info)

## 6.3 Preparations before Use

1) Turn on power switch, the device is automatically initialized.

2) Confirm the device is leveled.

If the device is not leveled, rotate horizontal adjusting knob to keep the air bubble in the spirit level in the middle.

3) Start up the combined tablet computer used and open the operation interface.

4) Press  to input the patient's PD, call the PD adjusting lens in the testing window.

5) Keep the patient's forehead on the base plate, the indicator is off.

6) The tester can observe the testee's eyes through testing window to make sure his eyes are in the center of the testing window.

7) Adjust corneal vertex distance (VD).

The tester can confirm the corneal vertex distance of the testee through cornea observation window, from which the tester should be 200mm-250mm away. Rotate the forehead baseplate knob, adjust the corneal vertex of the testee to needed position.

The corneal vertex is marked below:

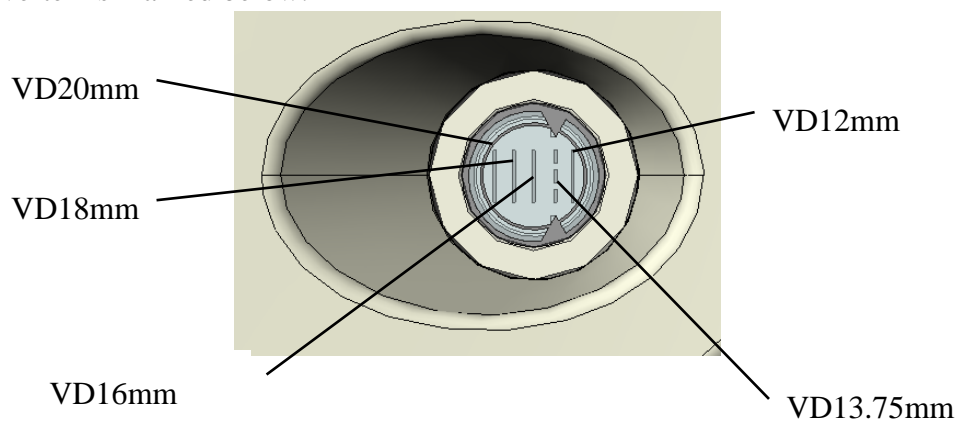

8) By tapping any position beyond PD entering interface, exit PD entering interface.

## 6.4 Standard Optometry Procedure

Press “” to start up standard optometry procedure .

1. Press  to input AR (computer refractor) measurement data:



2. Press  to begin SUBJ subjective correction.

Right eye scieropia. Baffle the left eye, change the cylindrical power of right eye to 0. Put on 0.5 sighting mark, and then gradually increase the positive spherical power until the 0.5 sighting mark becomes blurred.

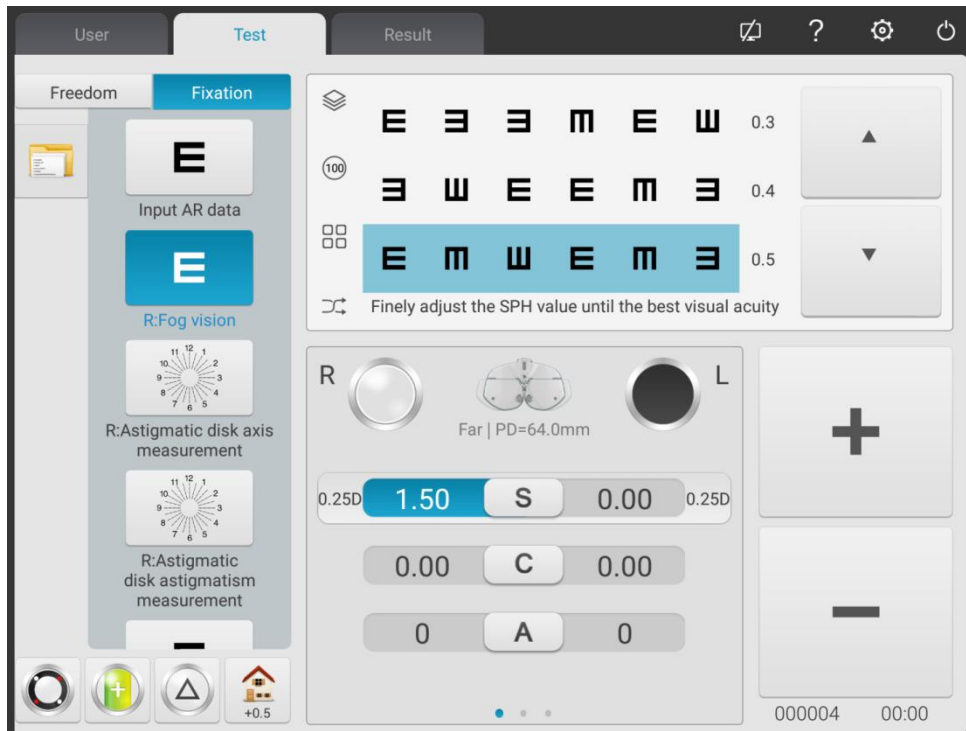

3. Press  to test the astigmatic axis with astigmatism disk.

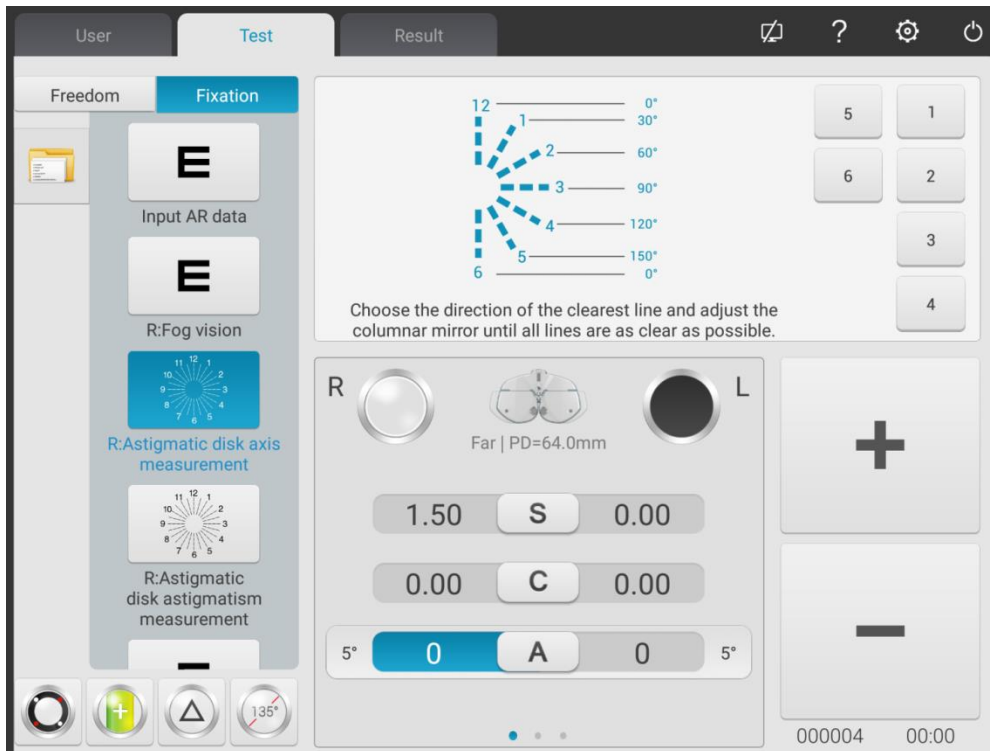



(1) Call in astigmatism disc sighting mark. Ask the patient:

- Do the definitions of all lines look the same?
- Which line looks especially distinct?

If the answers are:

- The definitions of all lines look the same.

No astigmatism.

- One line looks especially distinct.

Multiply the smaller figure (1~6) corresponding to the especially distinct line with 30°, the astigmatic axis of the negative cylinder can be obtained. For example: line 3-9 is especially distinct, the astigmatic axis is  $3 \times 30^\circ = 90^\circ$ .

(2) Input the obtained axis data

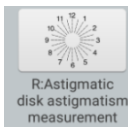

4. Press to test the astigmatic power with astigmatism disk.

Take -0.25D cylinder as increment, gradually adjust the cylindrical power until the definitions of lines to all directions in the astigmatism disc are the same.

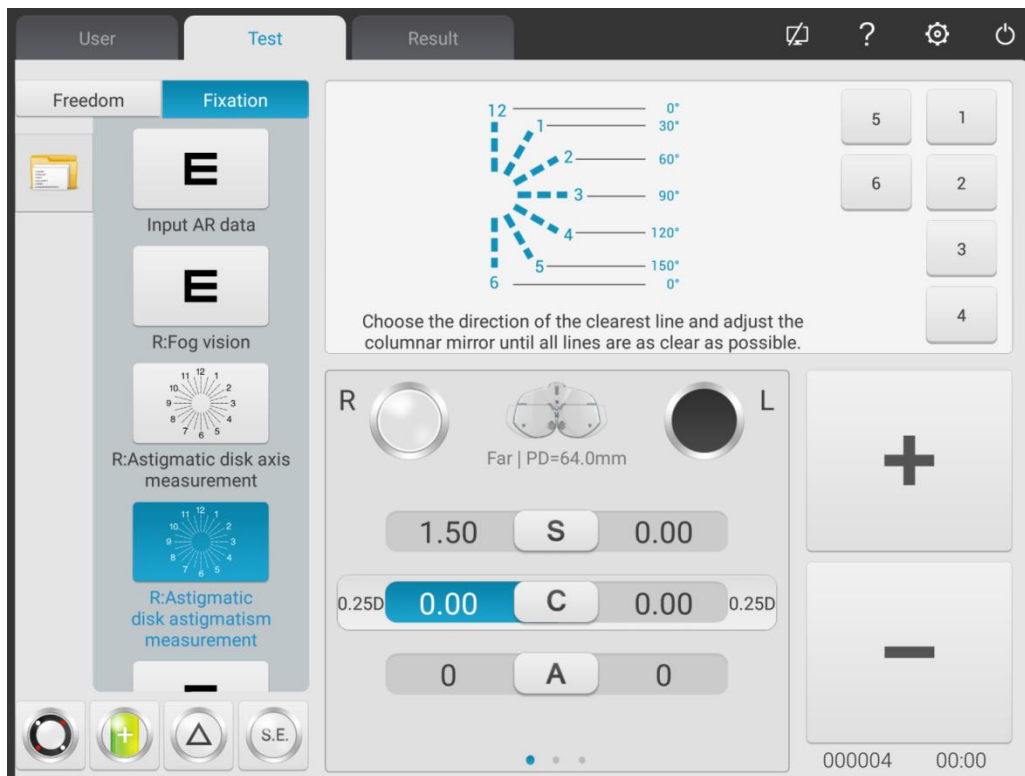



5. Press  and call in 0.8 sighting mark, take -0.25D sphere as increment to gradually adjust the spherical power until the patient sees the sighting mark clearly.

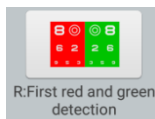

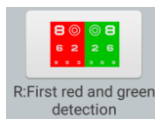
6. Press  to correct right eye spherical power with red and green sighting mark (first-time red and green test).

Call in spherical lens according to parameters settings. Call in red and green sighting marks.



1) Ask the patient: the letters in the red and green side of the sighting mark, which side looks more distinct?

If the letter in the red side looks more distinct: press “-” to increase -0.25D spherical power;

If the letter in the green side looks more distinct: press “+” to decrease -0.25D spherical power;

2) Repeat above steps until the definition of letters in the red side look the same as the definition of letters in the green side.

Attention: when the definitions of letters in the red and green side can not be adjusted consistent, make the letter in the red side more distinct.

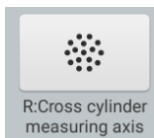

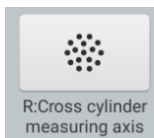
7. Press  to make the crisscross cylinder accurately test the astigmatic axis of the right eye.

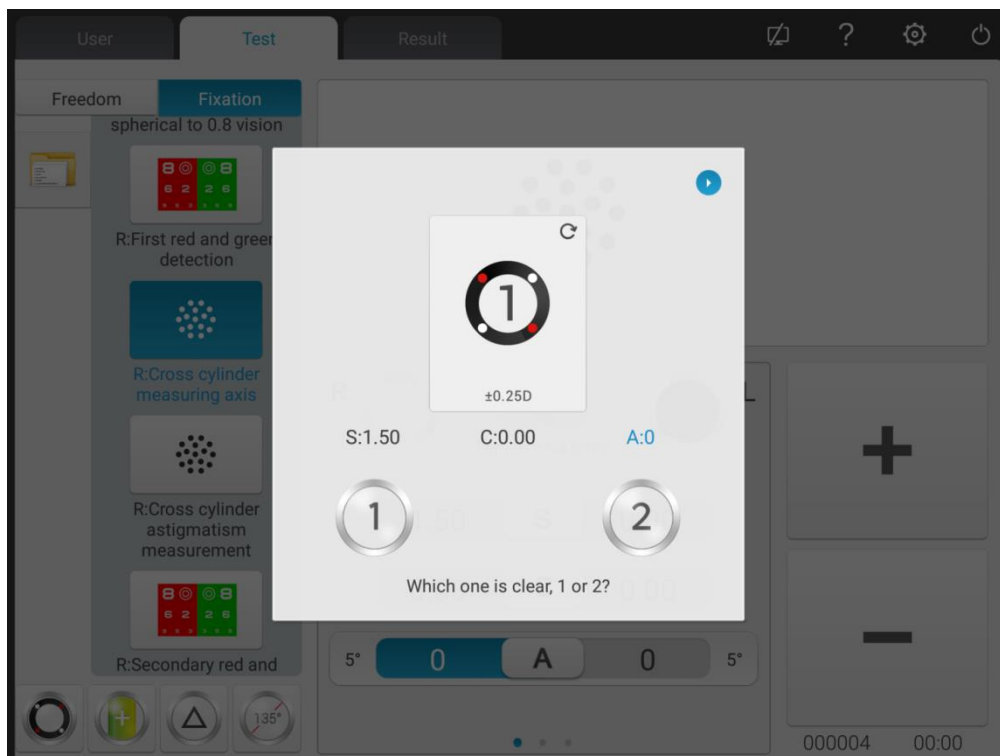

1) Call in speckle sighting mark and  $\pm 0.25D$  crisscross cylinder.

2) Reverse side 1 and side 2 of the crisscross cylinder, ask the patient: which side is more distinct?

When the side 1 is more distinct: enlarge the axis;

When the side 2 is more distinct: reduce the axis.

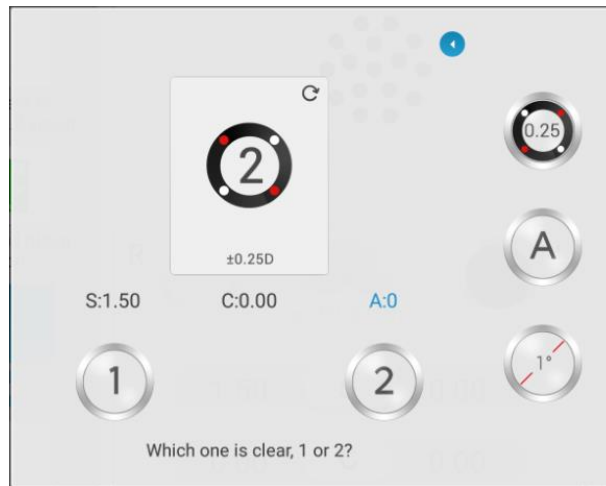

3) Repeat above steps until the definitions of side 1 and 2 look the same.

4) Click  key, shift to 0.5XC.

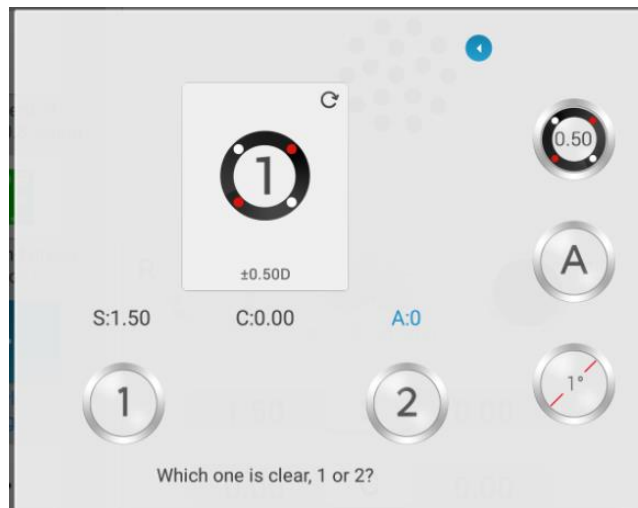

5) Click the key again, shift to automatic mode (Slit Prism).



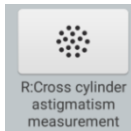

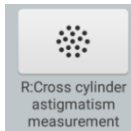
8. Press  to make the crisscross cylinder accurately test the astigmatic power of the right eye.

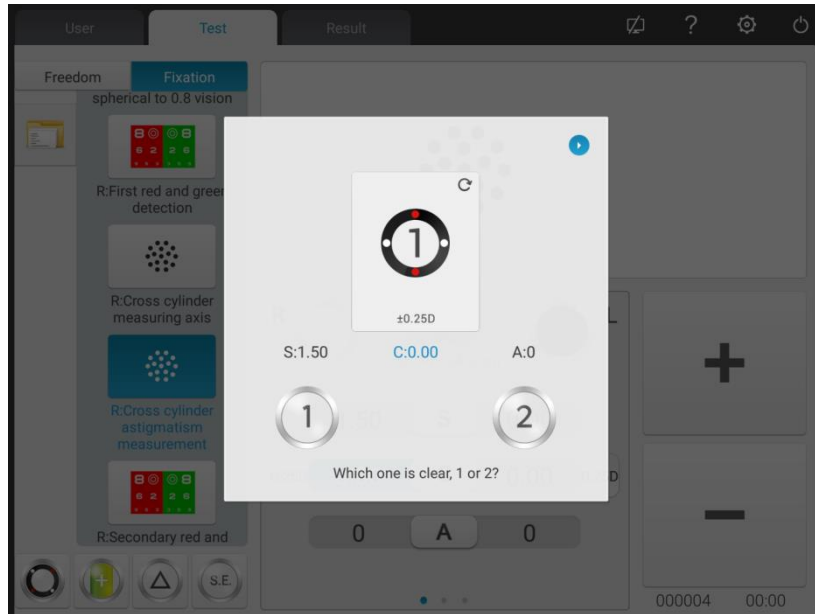

- 1) Reverse side 1 and side 2 of the crisscross cylinder, ask the patient: which side is more distinct?  
 When the side 1 is more distinct: enlarge the astigmatic power;  
 When the side 2 is more distinct: reduce the astigmatic power.
- 2) Repeat above steps until the definitions of side 1 and 2 look the same.

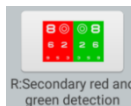

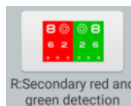
9. Press  to correct right eye spherical power with red and green sighting mark (second-time red and green test).

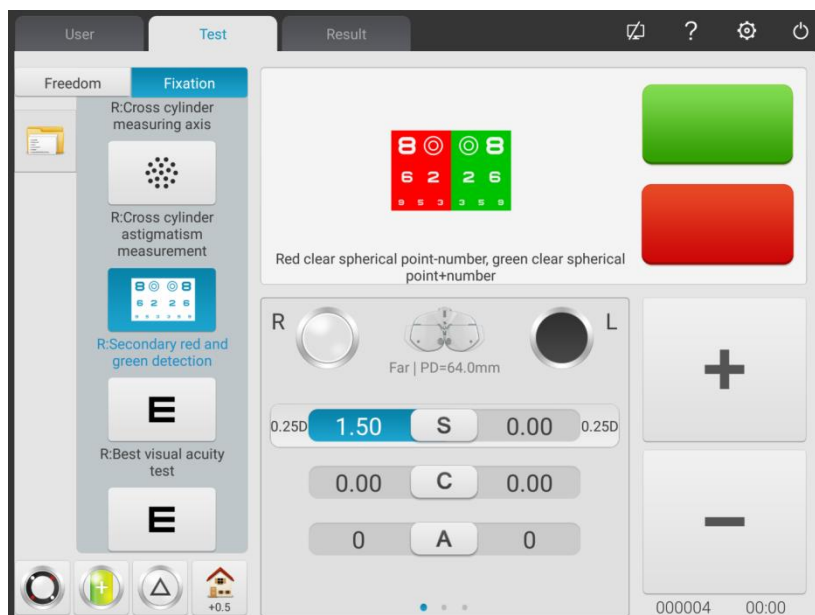

- 1) According to parameter settings call in spherical lens. Call in red and green sighting marks.
  - 2) Ask the patient: the letters in the red and green side of the sighting mark, which side looks more distinct?  
 If the letter in the red side looks more distinct: press “-” to increase -0.25D spherical power;  
 If the letter in the green side looks more distinct: press “+” to decrease -0.25D spherical power;
  - 3) Repeat above steps until the definition of letters in the red side look the same as the definition of letters in the green side.
- Attention: when the definitions of letters in the red and green side can not be adjusted consistent, make the letter in the red side more distinct.

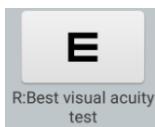

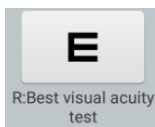
10. Press  to accurately adjust the spherical power to get the best vision of the right eye.



Call in 1.0 sighting mark. Adjust spherical power, and ask the patient to keep eyes on the sighting mark. Ask the patient when the sighting mark looks more distinct.  
 Take the lowest spherical power when the 1.0 sighting mark is clearly seen as the best vision of the right eye sphere.  
 So far, the SUBJ test for the right eye is finished.

11~19. Test the best vision of the left eye according to above step 2~10.

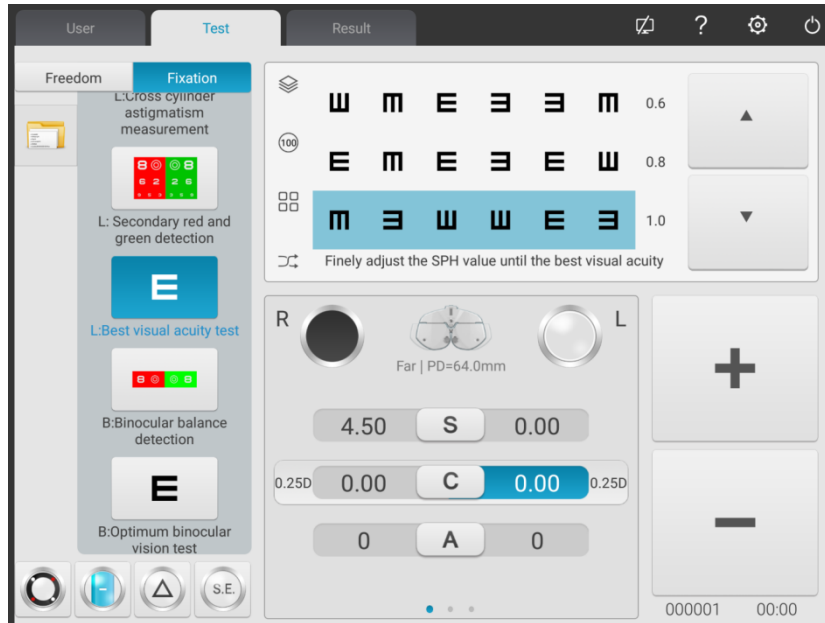

So far, the SUBJ test for the left eye is finished.



20. Press **B: Binocular balance detection** to begin binocular equilibrium test (FINAL test)



1) Open R and L testing windows. Call in binocular balance sighting mark, and  $3\Delta$  face-down prism for right eye and  $3\Delta$  face-up prism for left eye.

2) Ask the patients keep two eyes on the sighting mark and compare the definitions of upper and lower sighting marks.

If the upper sighting mark is more distinct than the lower sighting mark: press “+” to reduce  $-0.25D$

spherical power for the right eye;

If the lower sighting mark is more distinct than the upper sighting mark: press “+” to reduce -0.25D spherical power for the left eye

3) Repeat above steps until the definitions of two sighting marks look the same.

### 21. Binocular best vision correction



Reduce the spherical powers of two eyes by -1.00D synchronically, remove the prism in the binocular testing window, call in 1.0 sighting mark; enlarge the spherical powers of two eyes by -0.25D synchronically until the 1.0 sighting mark is clearly seen by two eyes.



22. Press  to begin Worth 4 dots test.





- 1) Call in red optical filter in R testing window and green optical filter in L testing window, and Worth 4 dots sighting mark.
- 2) Confirm which points the patient can see clearly.
- 3) Input the Worth 4 dots testing result.

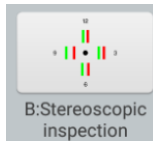

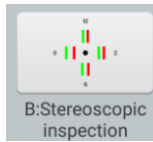
23. Press  to begin stereopsis testing.



- 1) Call in red optical filter in R testing window and green optical filter in L testing window, and stereo sighting mark.
- 2) Confirm if the patient can see four straight lines with stereo clearly.
- 3) Input the stereoscopic parallax testing result.

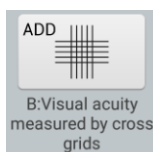

24. Press  to test additional degree

- 1) Lower down the short-distance vision rod and place the visual chart in necessary working distance (generally 400mm).
- 2) Select the crisscross matrix sighting mark on the short-distance visual chart.
- 3) Ask the patient: the horizontal line or the vertical line, which is more distinct? Or the horizontal line and the vertical line look the same?

If the horizontal line and the vertical line look the same: there is no need to carry out near vision test and change the additional degree.

If the horizontal line is more distinct than the vertical line: increase two eyes by +0.25D additional degree synchronically until the horizontal line looks as distinct as the vertical line.

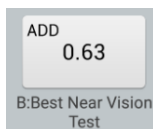
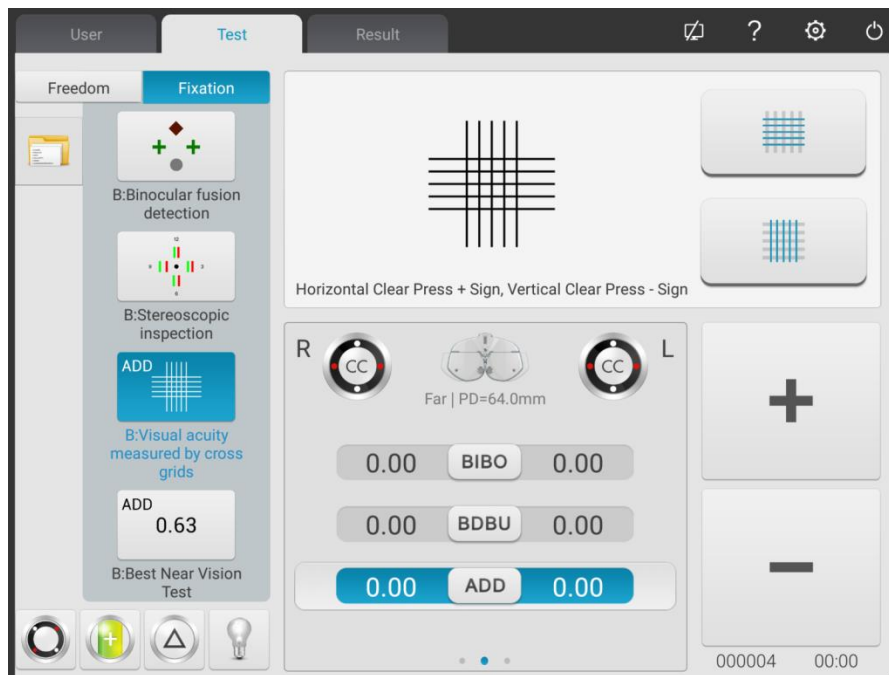

25. Press **ADD 0.63** to carry out near vision test.

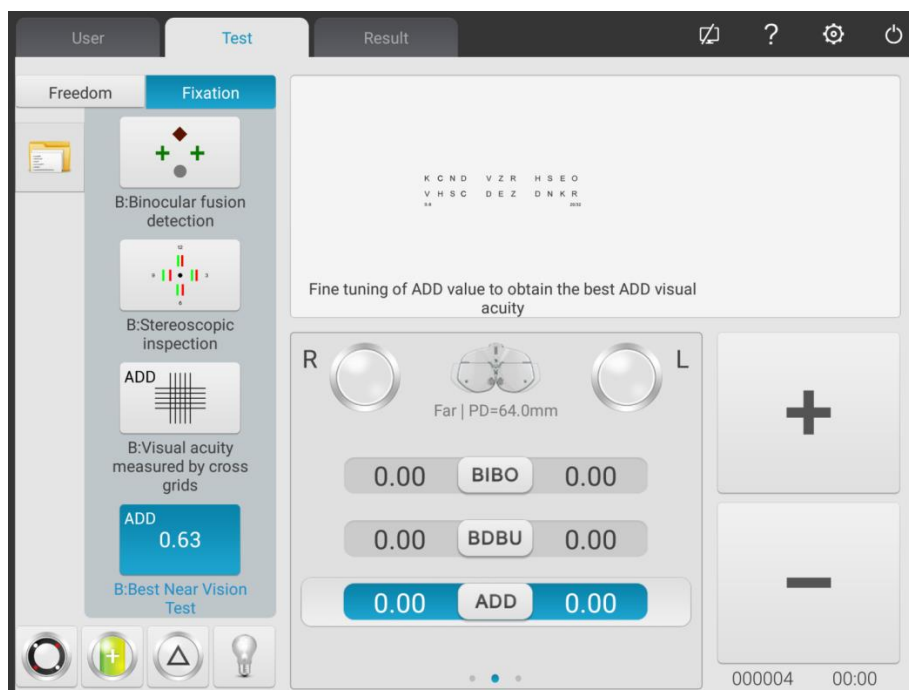

- 1) Remove  $\pm 0.50D$  fixed crisscross cylinder.
- 2) Select short-distance visual chart to test the vision.
- 3) Make the patient see the sighting mark clearly to reach ideal vision value.

## **6.5 Binocular Functional Testing Method**

### **6.5.1 ADD cross matrix test (presbyopia)**

Test purpose: to test the spherical power.

Test sighting mark: ADDcross matrix sighting mark

Assistant lens: binocular  $\pm 0.50D$  fixed crisscross cylinder

1. Binocular distant vision test is finished, add distant vision degree in the testing window.
2. Add binocular  $\pm 0.50D$  fixed crisscross cylinder.
3. Lower down the short-distance vision rod and place the visual chart in necessary working distance (generally 400mm).
4. Select the ADDcross matrix sighting mark on the short-distance visual chart.
5. Ask the patient: the horizontal line or the vertical line, which is more distinct? Or the horizontal line and the vertical line look the same?

If the horizontal line and the vertical line look the same: there is no need to carry out near vision test and wear presbyopia glasses.

If the horizontal line is more distinct than the vertical line: increase two eyes by  $+0.25D$  additional degree synchronically until the horizontal line looks as distinct as the vertical line.

6. Remove  $\pm 0.50D$  fixed crisscross cylinder.
7. Select short-distance visual chart to test the vision and slightly adjust the sphere to make the patient see the sighting mark clearly to reach ideal vision value.

### 6.5.2 Cross test (heterophoria)

Test purpose: To test heterophoria









Test sighting mark: Cross sighting mark

Assistant lens: Binocular rotatory prime

Right eye red optical filter, left eye green optical filter (red and green cross sighting mark)

Polarized optical filter

1. Call in cross sighting mark.
2. Ask the patient about the sighting mark he sees and test according his answers.

Sighting mark shape	Diagnosis	Correction
	No heterophoria	Align eye position, no need for correction.
	Esophoria	Increase BO prismatic power until it turns into a cross
	Exophoria	Increase BI prismatic power until it turns into a cross
	Left eye hyperphoria	Increase BU prismatic power in left eye and BD prismatic power in right eye until it turns into a cross
	Right eye hyperphoria	Increase BU prismatic power in right eye and BD prismatic power in left eye until it turns into a cross
	Esophoria + right eye hyperphoria	Correct the horizontal heterophoria according to esophoria method and correct the vertical heterophoria according to right eye hyperphoria until it turns into a cross.
	Esophoria + left eye hyperphoria	Correct the horizontal heterophoria according to esophoria method and correct the vertical heterophoria according to left eye hyperphoria until it turns into a cross.
	Exophoria + right eye hyperphoria	Correct the horizontal heterophoria according to exophoria method and correct the vertical heterophoria according to right eye hyperphoria until it turns into a cross.
	Exophoria + left eye hyperphoria	Correct the horizontal heterophoria according to exophoria method and correct the vertical heterophoria according to right eye hyperphoria until it turns into a cross.

Note: When adding prismatic power, only add one eye's prismatic power instead of two eyes' prismatic powers.

### 6.5.3 Cross fixation vision test (heterophoria)

Test purpose: to test heterophoria









Test sighting mark: cross fixation sighting mark

Assistant lens: Binocular rotatory prime

Right eye red optical filter, left eye green optical filter (red and green cross fixation sighting mark)

Polarized optical filter

1. Call in cross fixation sighting mark.
2. Ask the patient about the sighting mark he sees and test according his answers.

Sighting mark shape	Diagnosis	Correction
	No heterophoria	Align eye position, no need for correction.
	Esophoria	Increase BO prismatic power until it turns into a cross
	Exophoria	Increase BI prismatic power until it turns into a cross
	Left eye hyperphoria	Increase BU prismatic power in right eye and BD prismatic power in left eye until it turns into a cross
	Right eye hyperphoria	Increase BU prismatic power in left eye and BD prismatic power in right eye until it turns into a cross
	Esophoria + right eye hyperphoria	Correct the horizontal heterophoria according to esophoria method and correct the vertical heterophoria according to right eye hyperphoria until it turns into a cross.
	Esophoria + left eye hyperphoria	Correct the horizontal heterophoria according to esophoria method and correct the vertical heterophoria according to left eye hyperphoria until it turns into a cross.
	Exophoria + right eye hyperphoria	Correct the horizontal heterophoria according to exophoria method and correct the vertical heterophoria according to right eye hyperphoria until it turns into a cross.
	Exophoria + left eye hyperphoria	Correct the horizontal heterophoria according to exophoria method and correct the vertical heterophoria according to right eye hyperphoria until it turns into a cross.

Note: When adding prismatic power, only add one eye's prismatic power instead of two eyes'

prismatic powers.

### 6.5.4 Cross ring test (heterophoria)

Test purpose: to test heterophoria





Test sighting mark: cross ring sighting mark

Assistant lens: Binocular rotatory prime

Right eye red optical filter, left eye green optical filter (red and green cross ring sighting mark)

Polarized optical filter

1. Call in cross ring sighting mark.
2. Ask the patient about the sighting mark he sees and test according his answers.

Sighting mark shape	Diagnosis	Correction
	No heterophoria	Align eye position, no need for correction.
	Esophoria	Increase BO prismatic power until it the cross goes in the center of the circle.
	Exophoria	Increase BI prismatic power until it the cross goes in the center of the circle.
	Left eye hyperphoria	Increase BU prismatic power in right eye and BD prismatic power in left eye until it the cross goes in the center of the circle.
	Right eye hyperphoria	Increase BU prismatic power in left eye and BD prismatic power in right eye until it the cross goes in the center of the circle.

Note: When adding prismatic power, only add one eye's prismatic power instead of two eyes' prismatic powers.

### 6.5.5 Horizontal coincidence test (horizontal image inequality and horizontal heterophoria)

Test purpose: to test horizontal image inequality and horizontal heterophoria

Test sighting mark: horizontal coincidence sighting mark

Assistant lens: Binocular rotatory prime

Right eye red optical filter, left eye green optical filter (red and green horizontal coincidence sighting mark)

Polarized optical filter

1. Call in horizontal coincidence sighting mark.
2. Ask the patient about the sighting mark he sees and test according his answers.

#### Horizontal image inequality

If the sizes of the upper and lower frames are equivalent, there is no horizontal image inequality; if the sizes of the upper and lower frames are inequivalent, there is horizontal image inequality.

As shown in right figure: about 3.5% image inequality.

The straight line width of the sighting mark amounts to 3.5% image inequality.

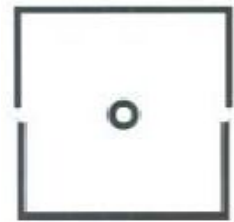

#### Horizontal heterophoria

Sighting mark shape	Diagnosis	Correction
	No heterophoria	Align eye position, no need for correction.
	Esophoria	Increase BO prismatic power until it the upper frame aligns at the lower frame.
	Exophoria	Increase BI prismatic power until it the upper frame aligns at the lower frame.

Note: When adding prismatic power, only add one eye's prismatic power instead of two eyes' prismatic powers.

### 6.5.6 Vertical coincidence test (vertical image inequality and vertical heterophoria)

Test purpose: to test vertical image inequality and vertical heterophoria

Test sighting mark: vertical coincidence sighting mark

Assistant lens: Binocular rotatory prime

Right eye red optical filter, left eye green optical filter (red and green vertical coincidence sighting mark)

Polarized optical filter

1. Call in vertical coincidence sighting mark.
2. Ask the patient about the sighting mark he sees and test according his answers.

#### Vertical image inequality



If the sizes of the upper and lower frames are equivalent, there is no vertical image inequality; if the sizes of the upper and lower frames are not equivalent, there is vertical image inequality.

As shown in right figure: about 3.5% image inequality.

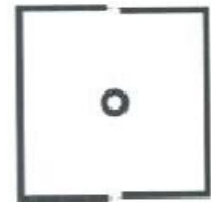
The straight line width of the sighting mark amounts to 3.5% image inequality.

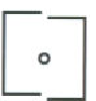

#### Vertical heterophoria

Sighting mark shape	Diagnosis	Correction
	No heterophoria	Align eye position, no need for correction.
	Right eye hyperphoria	Increase BU prismatic power in left eye and BD prismatic power in right eye until it the left frame aligns at the right frame.
	Left eye hyperphoria	Increase BU prismatic power in right eye and BD prismatic power in left eye until it the left frame aligns at the right frame.

Note: When adding prismatic power, only add one eye's prismatic power instead of two eyes' prismatic powers.

### 6.5.7 Horizontal Maddox rod test (horizontal heterophoria)



Test purpose: to test horizontal heterophoria

Test sighting mark: Maddox rod sighting mark



Assistant lens: right eye horizontal Maddox rod, left eye rotatory prism

1. Call in Maddox rod sighting mark.
2. Ask the patient about the sighting mark he sees and test according his answers.

Sighting mark shape	Diagnosis	Correction
	No heterophoria	Align eye position, no need for correction.
	Esophoria	Increase BO prismatic power for left eye until the white point coincides with the straight line.
	Exophoria	Increase BI prismatic power for left eye until the white point coincides with the straight line.

Note: When adding prismatic power, only add one eye's prismatic power instead of two eyes' prismatic powers.



### 6.5.8 Vertical Maddox rod test (vertical heterophoria)

Test purpose: to test vertical heterophoria

Test sighting mark: Maddox rod sighting mark

Assistant lens: left eye vertical Maddox rod, right eye rotatory prism

1. Call in Maddox rod sighting mark.
2. Ask the patient about the sighting mark he sees and test according his answers.

Sighting mark shape	Diagnosis	Correction
	No heterophoria	Align eye position, no need for correction.
	Left eye hyperphoria	Increase BU prismatic power in right eye until the white point coincides with the straight line.
	Right eye hyperphoria	Increase BD prismatic power in right eye until the white point coincides with the straight line.

Note: When adding prismatic power, only add one eye's prismatic power instead of two eyes' prismatic powers.

### 6.5.9 Clock test (rotatory heterophoria)

Test purpose: to test rotatory heterophoria



Test sighting mark: clock sighting mark

Assistant lens: Binocular rotatory prime

Right eye red optical filter, left eye green optical filter (red and green clock sighting mark)

Polarized optical filter

1. Call in clock sighting mark.
2. Ask the patient about the sighting mark he sees and test according his answers.

Sighting mark shape	Diagnosis	Correction
	No rotatory heterophoria	Align eye position, no need for correction.
	Idiopathic rotatory heterophoria	Functional rotatory heterophoria, can't be corrected with glasses
	Optical rotatory heterophoria	It might be caused by oblique astigmatism of human eyes or oblique cylinder of glasses. Make appropriate adjustment of cylindrical axil and power.





#### 6.5.10 Worth 4 dot test

Test purpose: to test binocular fusion, suppression and dominant eye.

Test sighting mark: Worth 4 dots sighting mark

Assistant lens: Right eye red optical filter, left eye green optical filter

1. Call in Worth 4 dots sighting mark.
2. Ask the patient about the sighting mark he sees and test according his answers.

Dot number	Sighting mark shape	Description	Diagnosis
4		Red squares and round dots, green crosses	Two eyes have fusion function Right eye is dominant eye
4		Red squares, green crosses and round dots	Two eyes have fusion function Left eye is dominant eye
3		Green squares and round dots	Right eye suppression
2		Red squares and round dots	Left eye suppression
5		Five points are seen at the same time	Diplopia

5	Flicker alternately	Two red points and three green points flicker alternately	Alternate suppression
---	---------------------	---	-----------------------

3. Input the testing results

### 6.5.11 Stereopsis

Test purpose: to test stereopsis

Test sighting mark: stereo sighting mark

Assistant lens: Right eye red optical filter, left eye green optical filter (red and green stereo sighting mark)

Polarized optical filter

1. Call in stereo sighting mark.

2. Ask the patient about the sighting mark he sees and test according his answers.

Marks in normal eyes during test: figure 12, 3, 6, 9 and the central round point are at the same plane, and four short lines protrude outwards; the distances from the short line aside figure 12, 3, 6 and 9 to the eye are seemingly shortened, and the short line aside figure 9 is the nearest.

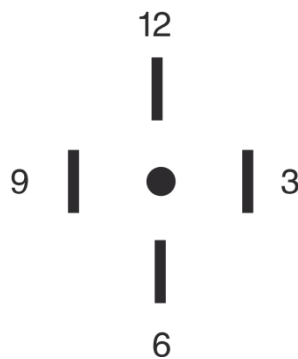

The stereoscopic parallaxes of all line are as follows:

The stereoscopic parallax between the short line aside figure 12 and the central round point is 10';

The stereoscopic parallax between the short line aside figure 12 and figure 3 is 1';

The stereoscopic parallax between the short line aside figure 3 and figure 6 is 2';

The stereoscopic parallax between the short line aside figure 6 and figure 9 is 4'.

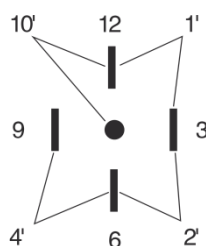

3. Input the testing results.

### 6.5.12 Divergence test

Test purpose: to test the eyes' congregation capability

Test sighting mark: the column sighting marks in the visual chart

Assistant lens: binocular rotatory prism

1. Under prism mode, press 

2. Press  to enter divergence test.

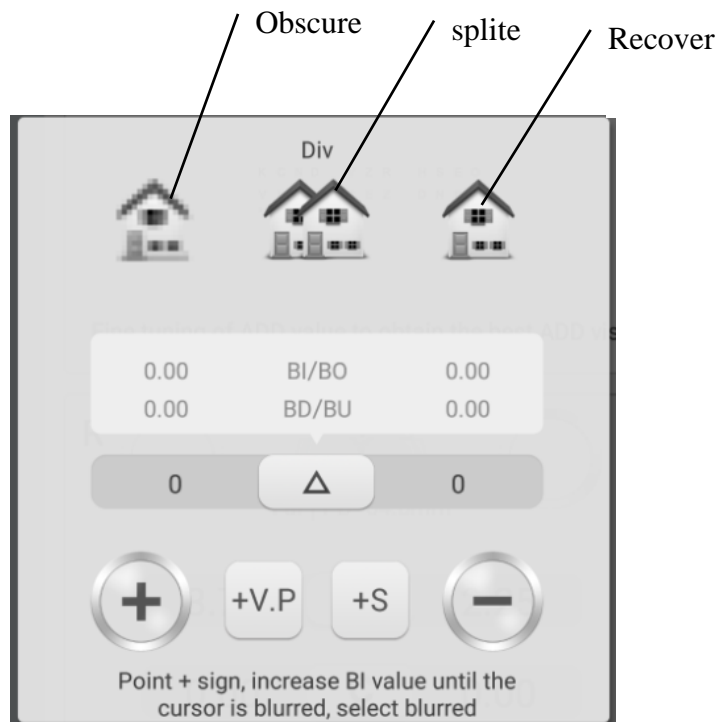

3. Call in the sighting marks and display column sighting marks.

4. Increase BI prismatic power of two eyes until the sighting mark becomes obscure. Press the obscure icon, and it is highlighted, then save the prismatic power of the obscure point.

5. Increase BI prismatic power of two eyes until the sighting mark splits into two. Press the split icon, and it is highlighted, then save the prismatic power of the split point.

6. Increase BI prismatic power of two eyes until the sighting mark recovers as one. Press the recover icon, and it is highlighted, then save the prismatic power of the recover point.

### 6.5.13 Congregation test

Test purpose: to test the eyes' congregation capability

Test sighting mark: the column sighting marks in the visual chart

Assistant lens: binocular rotatory prism

1. Under prism mode, press



2. Press



to enter congregation test.

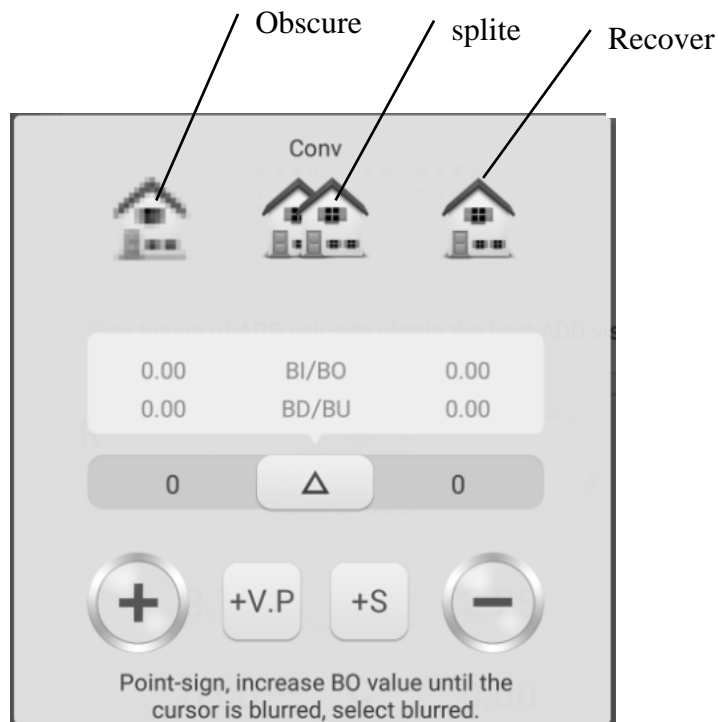

3. Call in the sighting marks and display column sighting marks.

4. Increase BO prismatic power of two eyes until the sighting mark becomes obscure. Press the obscure icon, and it is highlighted, then save the prismatic power of the obscure point.

5. Increase BO prismatic power of two eyes until the sighting mark splits into two. Press the split icon, and it is highlighted, then save the prismatic power of the split point.

6. Increase BO prismatic power of two eyes until the sighting mark recovers as one. Press the recover icon, and it is highlighted, then save the prismatic power of the recover point.

### 6.5.14 Near –point congregation (NPC) test

No vision tester is needed in the test. If the patient wears glasses, do not take them off.

Test purpose: to test split point

Test sighting mark: cross fixation sighting mark, or nib that can easily cause diplopia.

1. Press 

2. Press  to enter NPCtest.

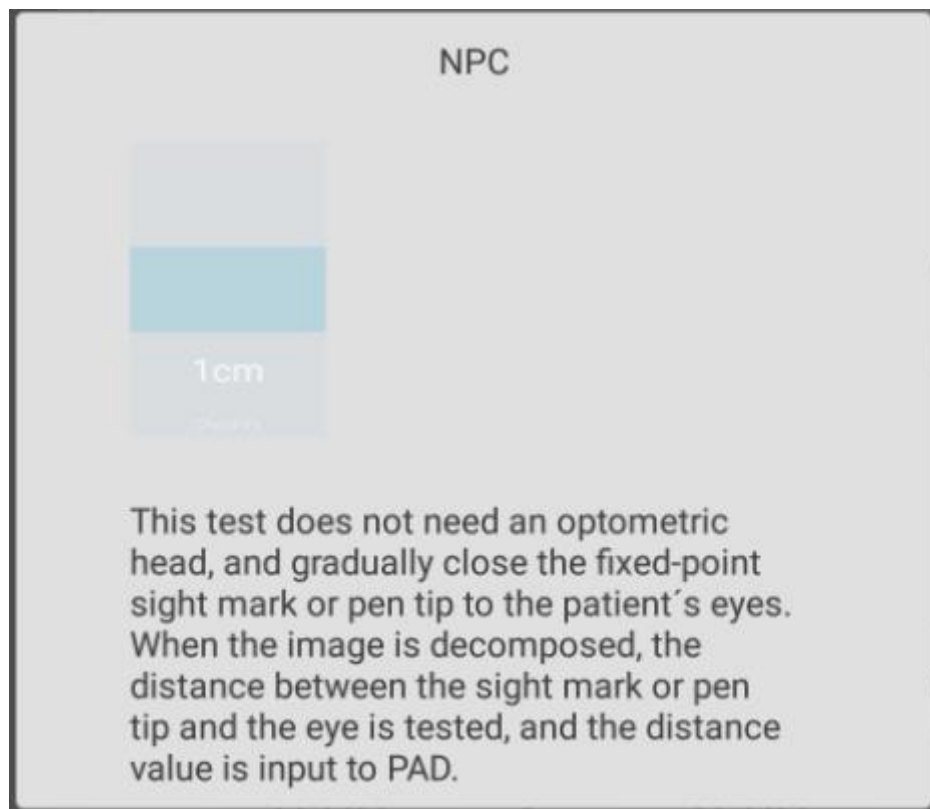

3. Put the nib in the right front of the patient and make the patient keep eyes on the nib.
4. Move the nib gradually to approach to the patient's eyes: when the patient sees the nib becomes two from one, stop moving the nib.
5. Measure the distance from the nib to the nose root of the patient.
6. Input the distance (unit cm) into the input frame, the meter angle and prismatic power will be calculated automatically.

### 6.5.15 Near –point adjustment (NPA) test

Test purpose: to test near-point adjustment

Test sighting mark: Letter sighting mark of short-distance visual chart.

Confirmation before test: Set “SPH distant vision → near vision” to SPH+ADD.

1. Press 

2. Press  to enter NPA test.

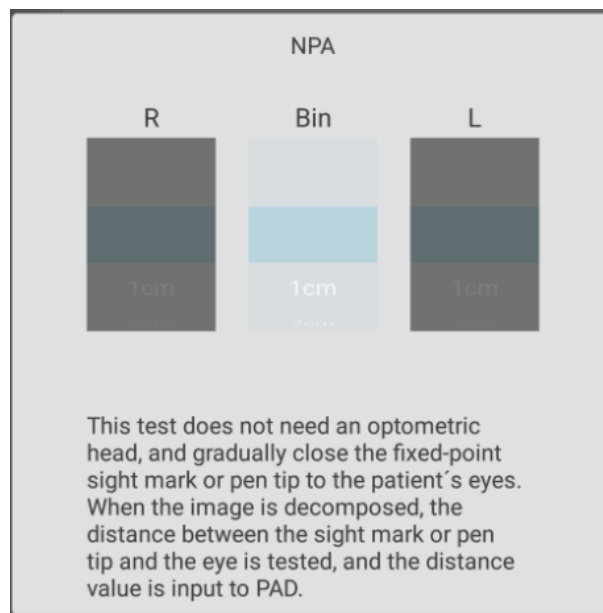

3. Place the visual chart in the distance of 40cm, make sure the patient see clearly the letter sighting mark with best vision.
4. Move the visual chart gradually to approach to the patient's eyes: when the sighting mark becomes obscure, stop moving the visual chart.
5. Measure the distance from the visual chart to the nose root of the patient.
6. Input the distance (unit cm) into the input frame, the near-point adjustment value will be calculated automatically.

### 6.5.16 Negative-relative adjustment (NRA) test

Test purpose: to test the negative-relative adjustment when the two eyes congregate in specified working distance

Test sighting mark: column sighting marks in short-distance visual chart

Confirmation before test: Set “SPH distant vision → near vision” to SPH+ADD.

1. Press 

2. Press  to enter NRA test.

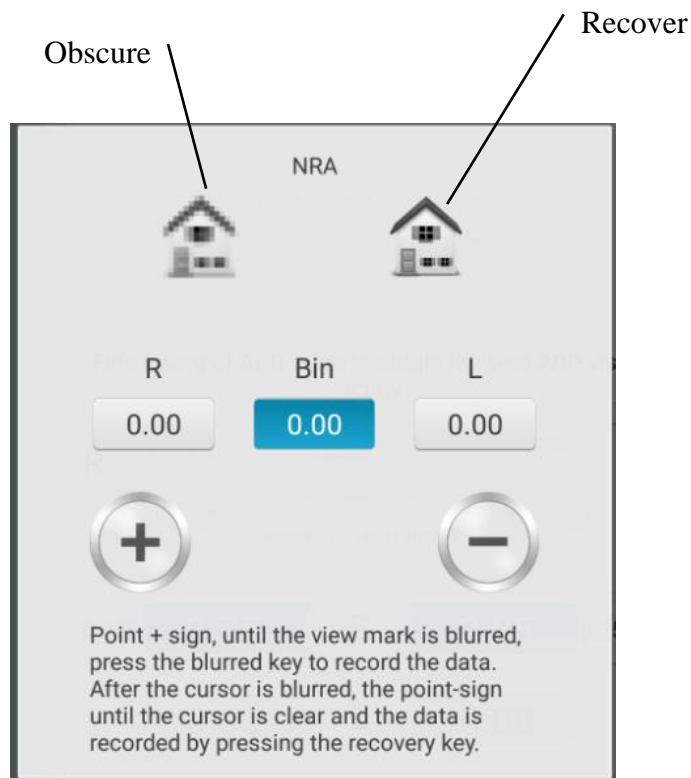

3. Place the visual chart in the distance of 40cm, make sure the patient see clearly the column sighting marks.

4. Press “+” and “-” to gradually adjust the spherical power until the sighting mark becomes obscure. Press the obscure icon, and it is highlighted, then save the spherical power of the obscure point.

5. Press “+” and “-” to gradually adjust the spherical power until the sighting mark becomes distinct again. Press the recover icon, and it is highlighted, then save the spherical power of the recover point.



### 6.5.17 Positive-relative adjustment (PRA) test

Test purpose: to test the positive-relative adjustment when the two eyes congregate in specified working distance

Test sighting mark: row sighting marks in short-distance visual chart

Confirmation before test: Set “SPH distant vision → near vision” to SPH+ADD.

1. Press 

2. Press  to enter PRA test.

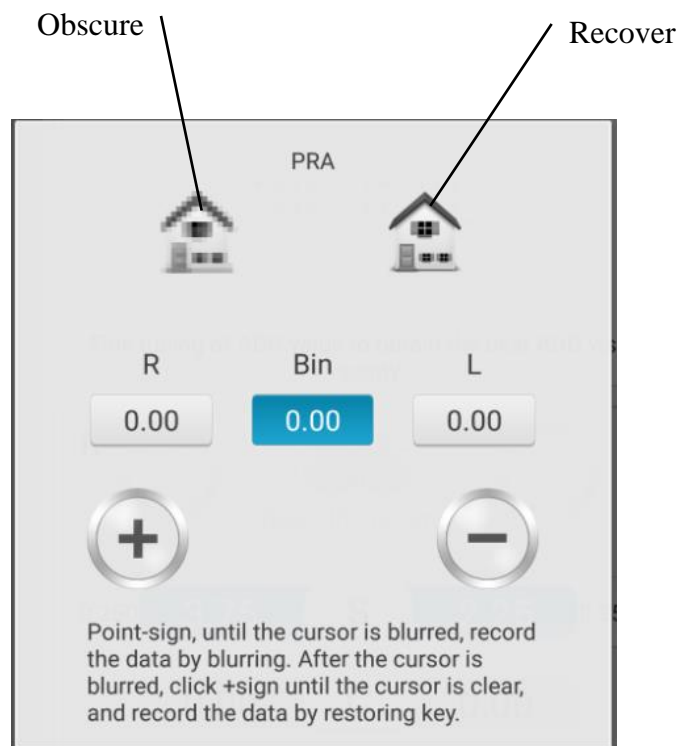

3. Place the visual chart in the distance of 40cm, make sure the patient see clearly the row sighting marks.

4. Press “+” and “-” to gradually adjust the spherical power until the sighting mark becomes obscure. Press the obscure icon, and it is highlighted, then save the spherical power of the obscure point.

5. Press “+” and “-” to gradually adjust the spherical power until the sighting mark becomes distinct again. Press the recover icon, and it is highlighted, then save the spherical power of the recover point.

## 6.6 Customer Self-compiled program

This device has standard optometric fixed programs as factory default settings. There are 6 customer self-compiled optometric programs.

### 6.6.1 Self-programming

1. Press button  on the left side of testing interface and enter optometric programs selecting interface, where 6 editable sets of programs (A, B, C, D, E, F) can be selected.

2. Select  “gear” and enter customer self-programming interface.

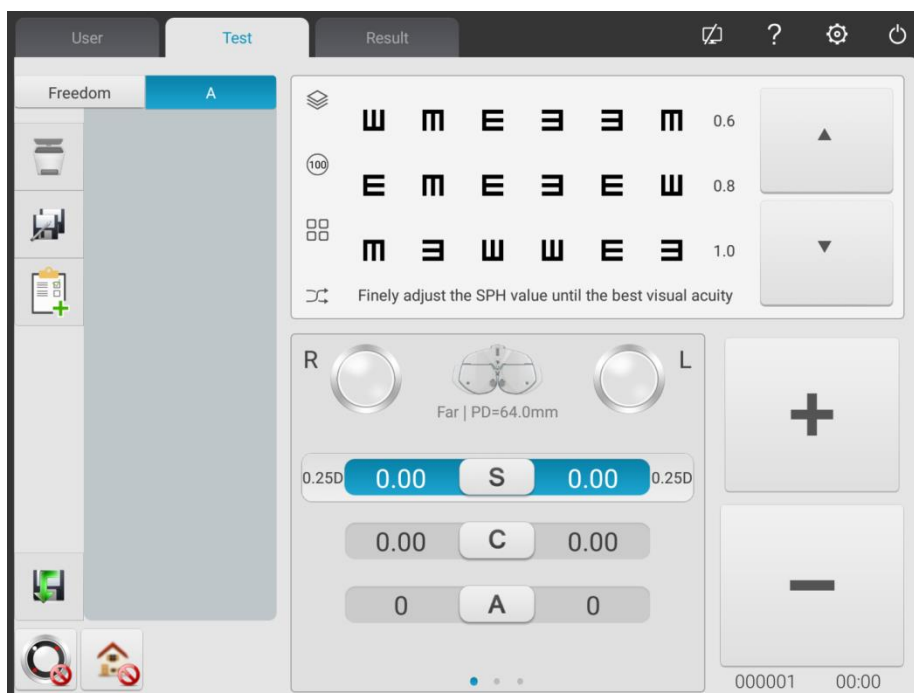

3. Introduction of buttons



Button Clear: delete the current step



Button Add: adding step



Button Edit: edit the current step

4. After programming press button  to automatically save self-compiled program, exit self-compiled program interface and return to the main interface.

## 6.6.2 Program running

1. Press button  in the testing interface.
2. Click on the required program. For example, select program A.
3. Self-compiled program starts to run.

## 6.7 Communication

### 6.7.1 Communication with Lensmeter CCQ-800

- 1) Use special communication cable to connect CCQ-800 to the R232 port of the print box.
- 2) Click LM key

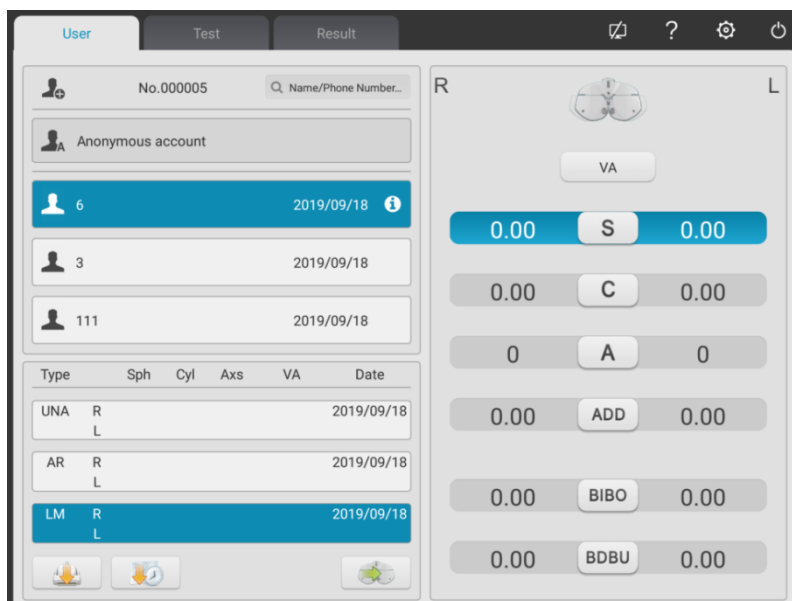

- 3) Click  key to popup input box

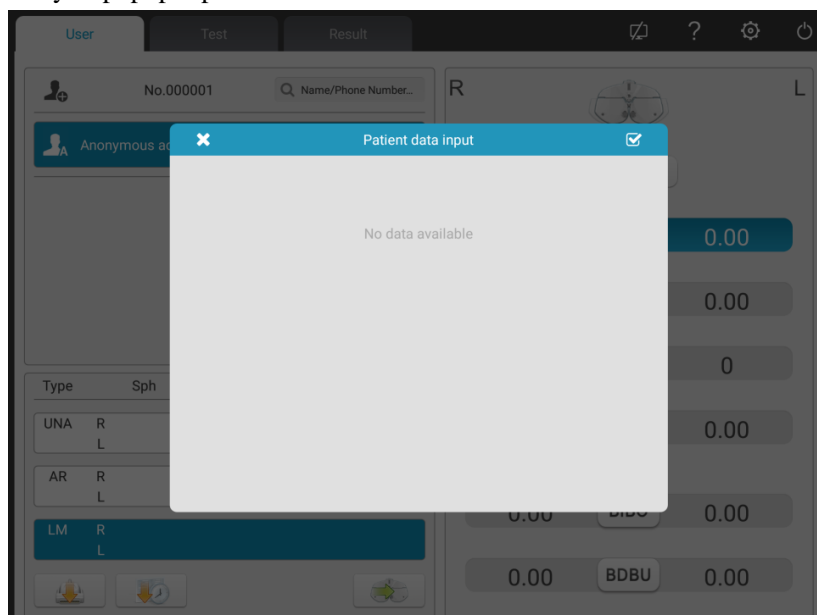

4) Use CCQ-800 lensmeter to test lens data and convey the date to YPA-2100

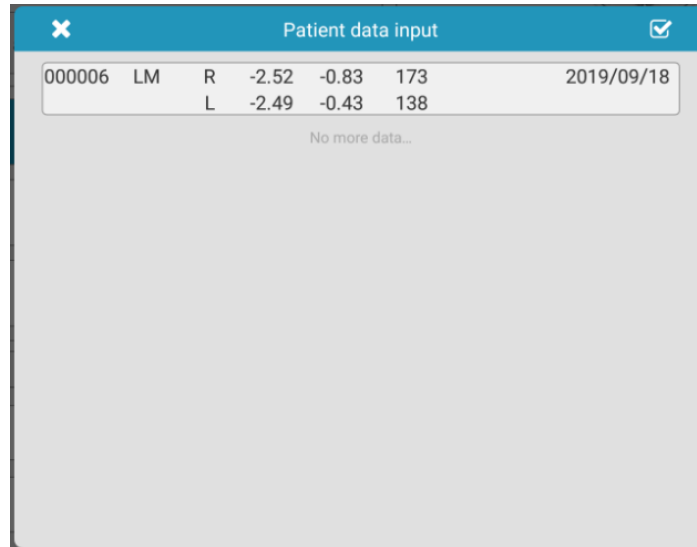

5) Choose "000006".

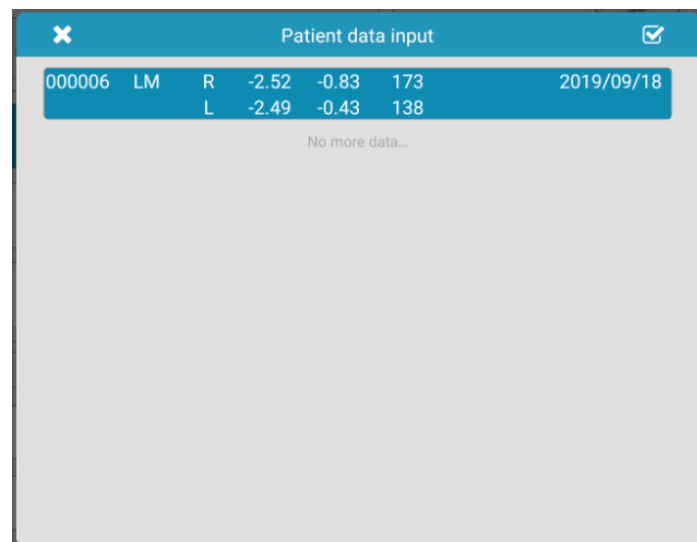

6) Click  key to complete data import.

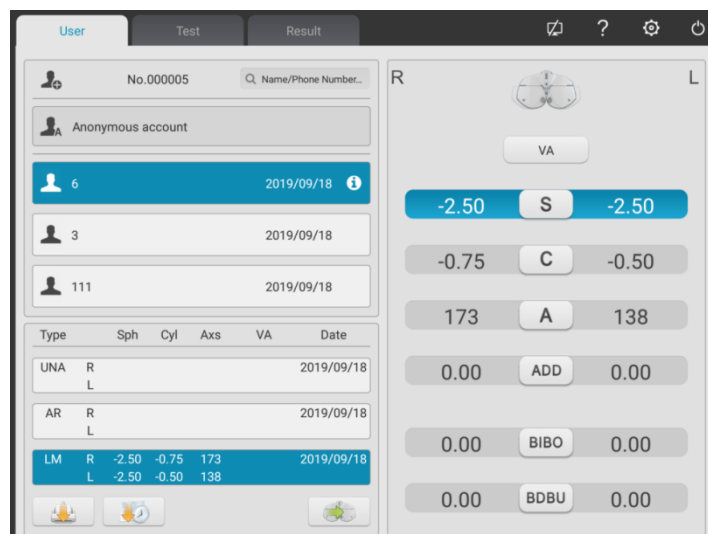

## 6.8 Pre-set ADD

### 6.8.1 Relationship table between pre-set additional degree ADD and patient age (only applies to this product)

Age	Pre-set ADD degree (D)
45 at oldest	0.75
50 at oldest	1.25
55 at oldest	1.50
60 at oldest	1.75
65 at oldest	2.00
Older than 65	2.25
N/A	Un-pre-set ADD degree

## 7. Troubleshooting

In the event of device trouble, please check the device as per below chart to obtain guidance. If the trouble is not shot, please contact with Chongqing Yeasn Science - Technology Co., Ltd. Maintenance Department or the authorized dealer.

Trouble	Reasons	Solutions
The device doesn't start	The power line is not correctly connected to the socket	Connect the power line correctly
The printer doesn't exit paper	Printing papers are used out	Replace printing papers
The printer doesn't print results	Printing papers are installed in opposite direction.	Adjust the direction of printing papers

## 8. Cleaning and Protection



Attention: Please unplug the power supply when cleaning. Do not use any corrosive detergent to clean the device, so as not to damage the device surface.

### 8.1 Clean the forehead baseplate

Clean the forehead baseplate before every optical test.

1) Take off the forehead baseplate

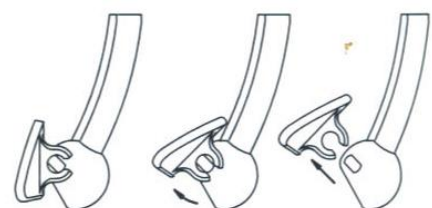

Tilt the forehead baseplate forward as shown in right figure: drag in a certain direction and take off

the baseplate.

#### 2) Clean the forehead baseplate

Wipe the forehead baseplate with clean and soft cloth. For intractable stains, please dip the clean soft cloth in mild detergent to scrub the stains away and then wipe it with dry soft cloth.

#### 3) Restore the forehead baseplate to original position

Insert it into the device in a certain direction.

### **8.2 Clean the nose baseplate**

Clean the nose baseplate before every optical test.

#### 1) Take off the nose baseplate from the vision tester host.

The nose baseplate is fixed on the vision tester host with magnetic steel, so it can be easily taken off.

#### 2) Clean the nose baseplate.

Wipe the nose baseplate with clean and soft cloth. For intractable stains, please dip the clean soft cloth in mild detergent to scrub the stains away and then wipe it with dry soft cloth.

#### 3) Restore the nose baseplate to original position.

### **8.3 Clean the testing window**

If there are dirt, oil stain, finger print or dust on the testing window, it may affect the testing accuracy.

#### 1) For the dust: blow it away with blowing balloon with brush.

#### 2) For dirt, oil stain and finger print: wipe it with clean and soft cloth.



Attention: Do not wipe the testing window with stiff cloth or paper; otherwise it may scratch the testing window glass.



Attention: Wipe the testing window gently when cleaning it. Otherwise, it may scratch the testing window glass.

### **8.4 Clean external parts**

When the external parts, such as the enclosure or panel, get dirty, please wipe them gently with clean and soft cloth.

For intractable stains, please dip the clean soft cloth in mild detergent to scrub the stains away and then wipe it with dry soft cloth.

## 9. Maintenance and Care

### 9.1 Replace printing papers

When a red line occurs beside the printing paper, please stop using the printer and replace printing papers.



Note: The printer of this product uses thermal printing paper with specification width 57mm.

Protection and maintenance is carried out by professional equipment management personnel to ensure the safe use of the product.

Replacing steps are as follows:

1) Press the printing bin button to open the printer cover.

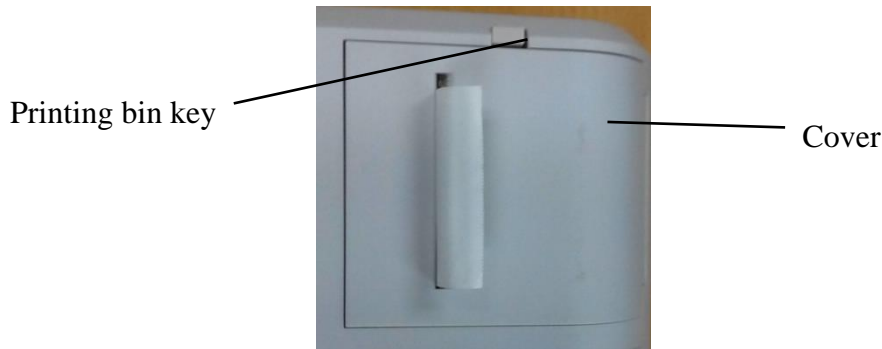

2) Take out the left paper and put in the new printing paper.

Attention: Pay attention to the paper roll's direction. If the paper roll is installed reversely, the printer won't print any data.

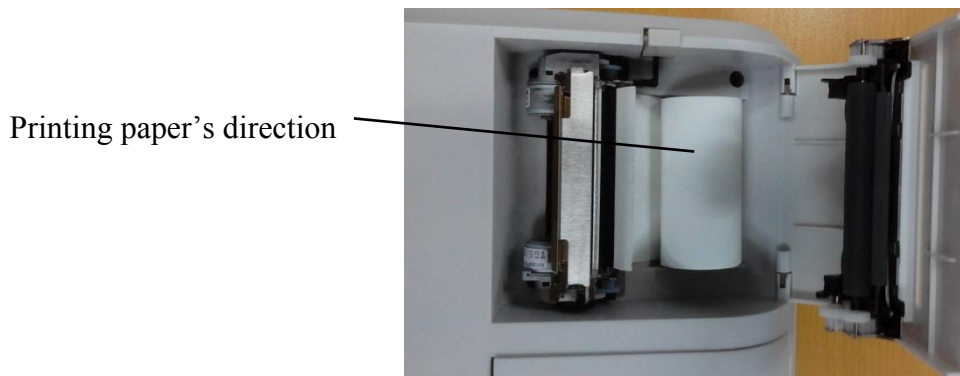

3) Put the printing paper through the paper exit and then close the printing cover.

Attention: Pay attention to the paper roll's direction. Do not print when there is no printing paper or pull the printing paper effortlessly, otherwise it may shorten the printer's service life.

Paper exit

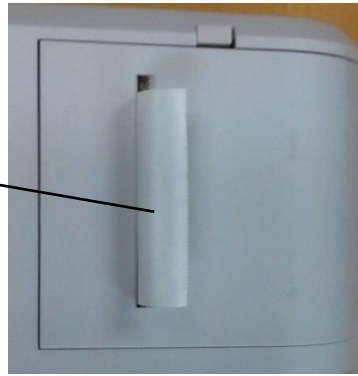

Press the print cover, be sure the "Printing bin key" is to the pop-up state, otherwise it will not be able to print.

9.2 Repairable and replaceable parts, such as printing base and power adapter, etc., provided by the company can only be used; other unauthorized parts may reduce the minimum safety of the device.

9.3 The fuse of the device is included in the power adapter; if damaged, please replace it with the power adapter provided by the company with fuse type of T2A 250V.

9.4 Do not disassemble or repair the device arbitrarily when a failure occurs, please contact with local dealer or manufacturer.

9.5 The company is committed to providing users with necessary circuit diagrams, part list and other relevant materials as needed.

## 10. Environmental Conditions and Service Life

### 10.1 Environmental conditions for normal operation

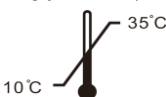
 Environment temperature: 10 °C ~ 35 °C

 Relative humidity: 30% ~ 85% (no condensation)

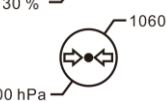
 Atmospheric pressure: 800 hPa ~ 1060 hPa

Indoor conditions: clean and without direct high light.

### 10.2 Environmental conditions for transportation and storage

 Environment temperature: -10 °C ~ 55 °C

 Relative humidity: 10% ~ 85% (no condensation)

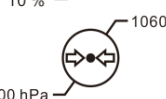
 Atmospheric pressure: 700 hPa ~ 1060 hPa



### **10.3 Service life**

The service life of the device is 8 years from first-time use with proper maintenance and care.

## **11. Disposal and Environmental protection**



### **INFORMATION FOR USERS**

Please recycle or properly dispose of the used batteries and other wastes to protect the environment.

This product bears the selective sorting symbol for waste electrical and electronic equipment (WEEE). This means that this product must be handled to the local collecting points or given back to retailer when you buy a new product, in a ratio of one to one pursuant to European Directive 2012/19/EU in order to be recycled or dismantled to minimize its impact on the environment.

Very small WEEE (no external dimension more than 25 cm) can be delivered to retailers free of charge to end-users and with no obligation to buy EEE of an equivalent type. For further information, please contact your local or regional authorities. Electronic products not included in the selective sorting process are potentially dangerous for the environment and human health due to the presence of hazardous substances. The unlawful disposal of the product carries a fine according to the legislation currently in force.

## **12. Manufacturer's Responsibility**

The company is responsible for the safety, reliability and performance impact under below circumstances:

Assembly, addition, modifications, alterations and repairs are carried out by authorized personnel by the company;

Electrical facilities in the room are in conformity with relevant requirements, and

The device is used according to the User Manual.

### 13. Electrical Schematic Diagram

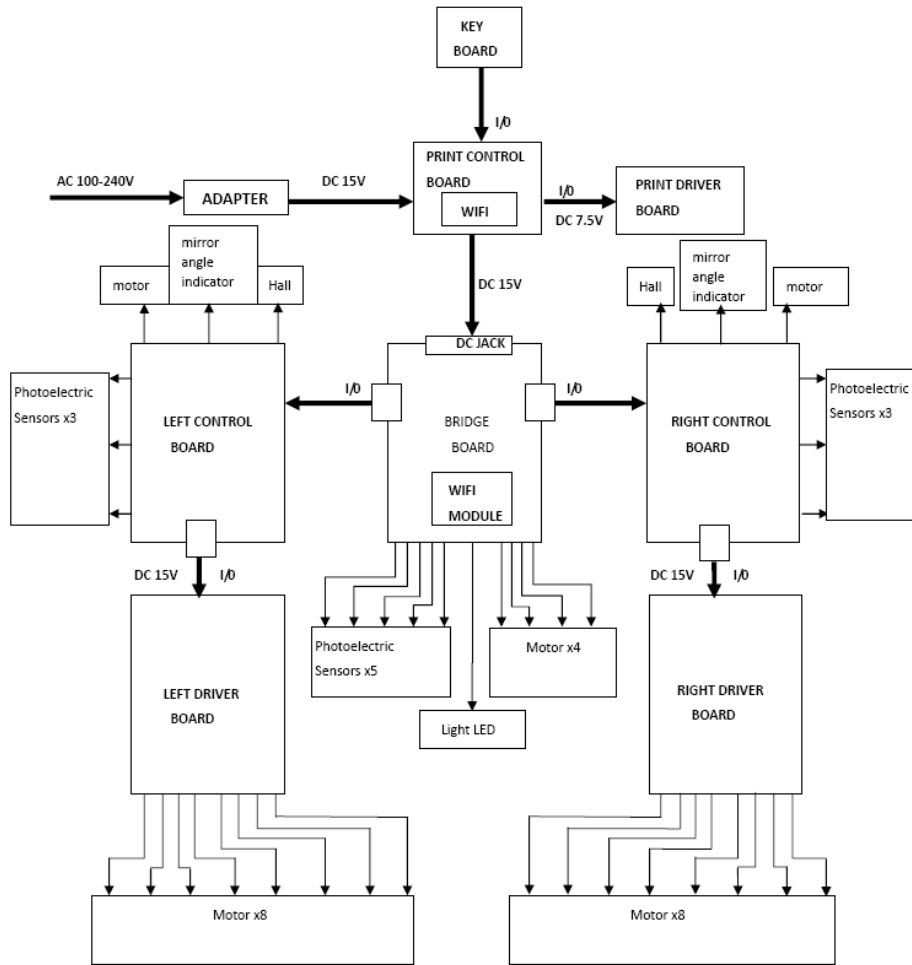

For further information and services, or any questions, please contact with the authorized dealer or manufacturer. We will be happy to help you.

### 14. Electromagnetic Compatibility

Guidance and Manufacturer’s Declaration – Electromagnetic Emissions		
This device is intended for use in the electromagnetic environment specified below. The customer or the user of the devices should assure that the device is used in such an environment.		
Emissions test	Compliance	Electromagnetic environment - guidance
RF emissions GB 4824(CISPR 11)	Group 1	The device is suitable for use in all establishments, including domestic establishments and those directly connected to the public low-voltage network that supplies building used for domestic purposes.
RF emissions GB 4824(CISPR 11)	Class B	
Harmonic emissions GB 17625.1	Class A	
Voltage Fluctuations/Flicker GB 17625.2 (IEC 61000-3-3)	Complies	

Guidance and Manufacturer's Declaration – Electromagnetic Immunity			
This device is intended for use in the electromagnetic environment specified below. The customer or the user of the devices should assure that the device is used in such an environment.			
Immunity test	IEC60601 Test level	Compliance level	Electromagnetic environment - guidance
Electrostatic discharge(ESD) GB/T 17626.2 (IEC61000-4-2)	±8kV Contact ±15kV Air	±8kV Contact ±15kV Air	Floor should be wood, concrete or ceramic tile. If floors are covered with synthetic material, the relative humidity should be at least 30%.
Electrical fast transient/burst GB/T 17626.4 (IEC61000-4-4)	±2kV for power supply lines ±1kV for input/output lines	±2kV for power supply lines ±1kV for input/output lines	Mains power quality should be that of a typical commercial or hospital environment.
Surge GB/T 17626.5 (IEC61000-4-5)	±1kV line to line ±2kV line to earth ±1kV line to line ±2kV line to earth	±1kV line to line ±2kV line to earth	Mains power quality should be that of a typical commercial or hospital environment.
Voltage dips, short interruptions and voltage variations on power supply input lines GB/T 17626.11 (IEC61000-4-11)	<5% Ut (>95% dip in Ut) for 0.5 cycle 40% Ut (60% dip in Ut) for 5 cycles 70% Ut (30% dip in Ut) for 25 cycles <5% Ut (>95% dip in Ut) for 5 sec	<5% Ut (>95% dip in Ut) for 0.5 cycle 40% Ut (60% dip in Ut) for 5 cycles 70% Ut (30% dip in Ut) for 25 cycles <5% Ut (>95% dip in Ut) for 5 sec	Mains power quality should be that of a typical commercial or hospital environment. If the user of the device requires continued operation during power mains interruptions, it is recommended that the device be powered from an uninterruptible power source.
Power frequency magnetic field(50/60Hz) GB/T 17626.8 (IEC 61000-4-8)	3 A/m	3 A/m	Power frequency magnetic fields should be at levels characteristic of a typical location in a typical commercial or hospital environment.
Note: Ut is the AC mains voltage prior to application of the test level.			

Guidance and Manufacturer's Declaration – Electromagnetic Immunity

This device is intended for use in the electromagnetic environment specified below. The customer or the user of the devices should assure that the device is used in such an environment.

Immunity test	IEC60601 Test level	Compliance level	Electromagnetic environment - guidance
<p>Conducted RF GB/T 17626.6 (IEC61000-4-6) Radiated RF GB/T 17626.3 (IEC61000-4-3)</p>	<p>3 V (effective value) 150kHz - 80MHz 3 V/m 80MHZ - 2.5GHZ</p>	<p>3 V 3V (effective value) 3 V/m</p>	<p>Portable and mobile RF communications equipment should be used no closer to any part of the device, including cables, than the recommended separation distance calculated from the equation applicable to the frequency of the transmitter. Recommended separation distance d =1.2 150kHz-80MHz d =1.2 80MHz-800MHz d =2.3 800MHz-2.5GHz Where: P is the maximum output power rating of the transmitter in watts (W) according to the transmitter manufacturer;  D is the recommended separation distance in meters (m). Field strengths from fixed RF transmitters, as determined by an electromagnetic site survey <sup>a</sup> should be less than the compliance level in each frequency range <sup>b</sup>. Interference may occur in the vicinity of equipment marked with the following symbol.</p> 

Note 1: At 80MHz and 800MHz, the higher frequency range applies.

Note 2: These guidelines may not apply in all situations. Electromagnetic propagation is affected by absorption and reflection structures, objects and people.

<sup>a</sup> Field strengths from fixed transmitters, such as base stations for radio (cellular/cordless) telephones and land mobile radios, amateur radio, AM and FM radio broadcast and TV broadcast cannot be predicted theoretically with accuracy. To assess the electromagnetic environment due to fixed RF transmitters, an electromagnetic site survey should be considered. If the measured field strength in the location in which the device is used exceeds the applicable RF compliance level above, the device should be observed to verify normal operation. If abnormal performance is observed, additional measures may be necessary, such as reorienting or relocating the device.

<sup>b</sup> Over the frequency range 150 KHz to 80MHz, field strengths should be less than 10V/m.

Recommended separation distances between portable and mobile RF communications equipment and the device

These devices are intended for use in an environment in which radiated RF disturbances are controlled.

The customer or the user of the device can help prevent electromagnetic interference by maintaining a minimum distance between portable and mobile RF communications equipment (transmitters) and the device as recommended below, according to the maximum output power of the communication equipment.

Rated maximum output power of transmitter W	Separation distance according to frequency of transmitter/m		
	150kHz - 80MHz d = 1.2	80MHz - 800MHz d = 1.2	800MHz - 2.5GHz d = 2.3
0.01	0.12	0.12	0.23
0.1	0.38	0.38	0.73
1	1.2	1.2	2.3
10	3.8	3.8	7.3
100	12	12	23

For transmitters rated at a maximum output power not listed above, the recommended separation distance d in meters (m) can be determined using the equation applicable to the frequency of the transmitter, where P is the maximum output power rating of the transmitter in watts (W) according to the transmitter manufacturer.

Note 1: At 80MHz and 800MHz, the separation distance for the higher frequency range applies.

Note 2: These guidelines may not apply in all situations. Electromagnetic propagation is affected by absorption and reflection from structures, objects and people.